

HSEUreg04801

DIN Rail

Made in Germany

480W Programmable DC Power Supply

Short Specification:

- Metal housing
- 90% efficiency
- -25°C...+60°C full output power
- Natural convection
- Galvanic insulated
- Continuous short circuit protected
- Overload (OVP) & low voltage protected
- Soft start & auto-recovery
- Hold up time >50ms
- No base load required
- Analogue interface 0-10Vdc/0-20mA/4-20mA(option)
- External shutdown
- Sense control
- Series & parallel operation
- DIN Rail 35mm & wall mount
- Screw terminals AWG20...AWG6
- High reliability, shock & vibration proof
- 24 hours burn in test
- EMI/EMS EN61000-6-2,3, EN55022 class B
- IEC(EN)60950-1 in accordance to cUL60950/16950

Available outputs: 0...18V, 0...30V, 0...50V, 0...90V, 0...130V, 0...180V, 0...240V

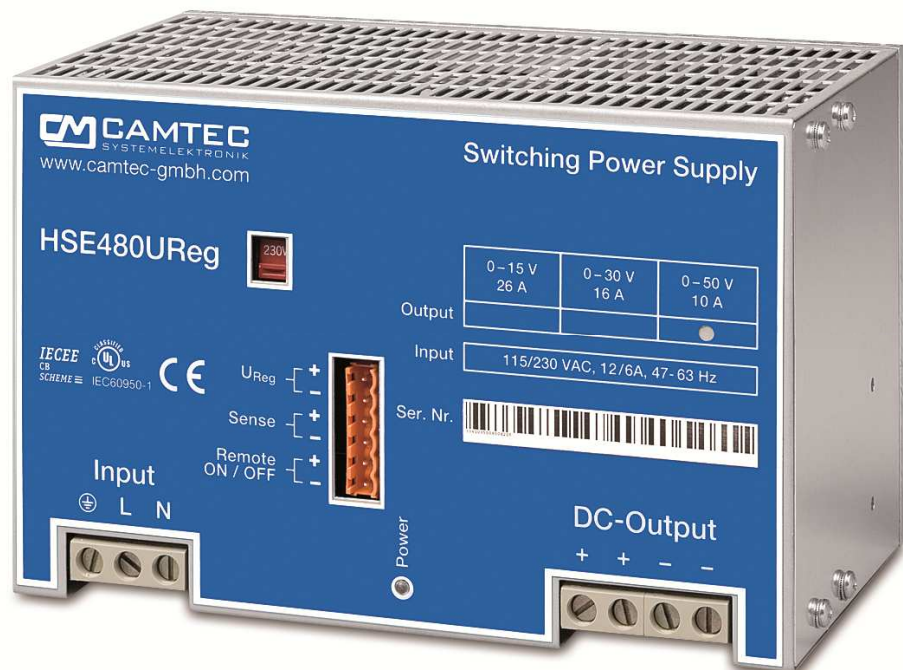

In accordance with IEC60950-1

| | | | | | | | |
|--------------------------------|---|---------|---------|---------|----------|----------|---------|
| AC Input | 90..132Vac / 184..265Vac , 47...63Hz , 250...375Vdc | | | | | | |
| AC Input Rating | 115Vac<8.8A 230Vac<4.3A 250Vdc<2.4A 375Vdc<1.6A | | | | | | |
| Rated DC Voltage | 0...15V | 0...30V | 0...50V | 0...90V | 0...130V | 0...180V | 0..240V |
| Oversvoltage Protection | 18Vdc | 35Vdc | 59Vdc | 105Vdc | 150Vdc | 210Vdc | 280Vdc |
| Rated DC Current | 26A | 16A | 10A | 5.3A | 3.7A | 2.7A | 2.0A |
| Power Boost -25...+60°C <1min. | 28.6A | 17.6A | 11A | 5.8A | 4.1A | 3.0A | 2.2A |
| Max. DC Current +70°C | 19.5A | 12A | 7.5A | 4A | 2.8A | 2A | 1.5A |
| Ripple Peak 230Vac 20MHz | 40mVpp | 50mVpp | 100mVpp | 150mVpp | 200mVpp | 300mVpp | 400mVpp |
| Sense function | Compensation 2V per lead load, protective electrical separation ≤60Vdc | | | | | | |
| Remote Shutdown | protective electrical separation ≤60Vdc | | | | | | |
| Analogue Interface | see table, 4-20mA available option, protective electrical separation ≤60Vdc, work.res.=500Ω | | | | | | |
| Pmax | 480W continuous | | | | | | |
| Derating | +60°C...+70°C 2.5%/ °C | | | | | | |
| Accuracy | < ± 1.5% Interface | | | | | | |
| Latency Interface | t.b.d. | | | | | | |
| Load regulation | < ± 0.2% 0-100% | | | | | | |
| Response Load Change | <1ms 10-100%, 100-10% | | | | | | |
| Base Load | None | | | | | | |
| Efficiency 230Vac | 90% typical | | | | | | |
| Short Circuit Protection | Continuous | | | | | | |
| Idling-proof | Yes | | | | | | |
| Temperature Control | Yes, thermal shutdown with auto recovery (+70°C, metering distance 10mm) | | | | | | |
| Hold Up Time | > 50ms 230Vac | | | | | | |
| Inrush Current | < 81A (230Vac) | | | | | | |
| Softstart | 100ms typical | | | | | | |
| Cooling | Natural convection | | | | | | |
| Ambient Operating Temp. | - 25°C...+70°C | | | | | | |
| Ambient Storage Temp. | - 40°C...+85°C | | | | | | |
| Environment | Humidity 95% non-condensing @ 25°C, climate class . 3k3, pollution rate II | | | | | | |
| EMI | EN55022 class B | | | | | | |
| EMS | EN61000-6-2,3 | | | | | | |
| Safety | cUL60950, EN60950-1 | | | | | | |
| Safety class 1(A) | VDE0805, VDE0100 | | | | | | |
| Isolation Path | > 8mm | | | | | | |
| Input / Output | Galvanic insulated | | | | | | |
| Meantime By Failure (MTBF) | 400000h (IEC61709) | | | | | | |
| Dimensions (HxWxD) | 130x200x114,5mm | | | | | | |
| Weight | 2900g | | | | | | |
| Screw Terminals (In/Out) | AWG20...AWG6 , 0.5...16mm ² (76A @ 40°C) | | | | | | |

| | |
|------------------|------------------------|
| Interface | |
| Programme [V] | 0...10Vdc |
| Programme [A] | 0...20mA |
| Programme [A] | 4...20mA ¹⁾ |
| Shutdown | External |
| Sensing | 2V lead load |

¹⁾ option

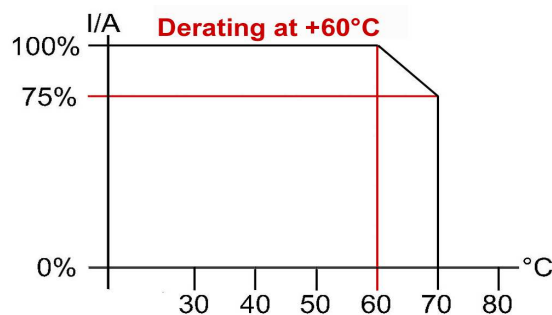
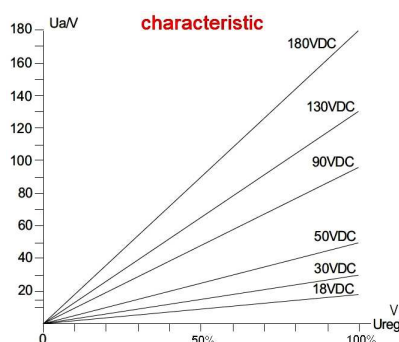

Ordering Information:

| Output | Type (DIN-Rail standard) | Part Number | Option | Part Number |
|----------|--------------------------|----------------|---------------------------|--|
| 0...18V | HSEUreg04801.18T | 304.1051.001CA | Backplate kit (wallmount) | 220.1002.001CA |
| 0...30V | HSEUreg04801.30T | 304.1051.002CA | | |
| 0...50V | HSEUreg04801.50T | 304.1051.003CA | ADTW201 DC-repeater | 304.1090.001CA |
| 0...90V | HSEUreg04801.90T | 304.1051.004CA | | |
| 0...130V | HSEUreg04801.130T | 304.1051.005CA | 4..20mA option | Ad 420 to the type number example: HSEUreg04801.15T420 |
| 0...180V | HSEUreg04801.180T | 304.1051.006CA | | |
| 0...240V | HSEUreg04801.240T | 304.1051.007CA | Screw terminal plug | 3520037 2pol. LS5,08 (package=10pcs) |

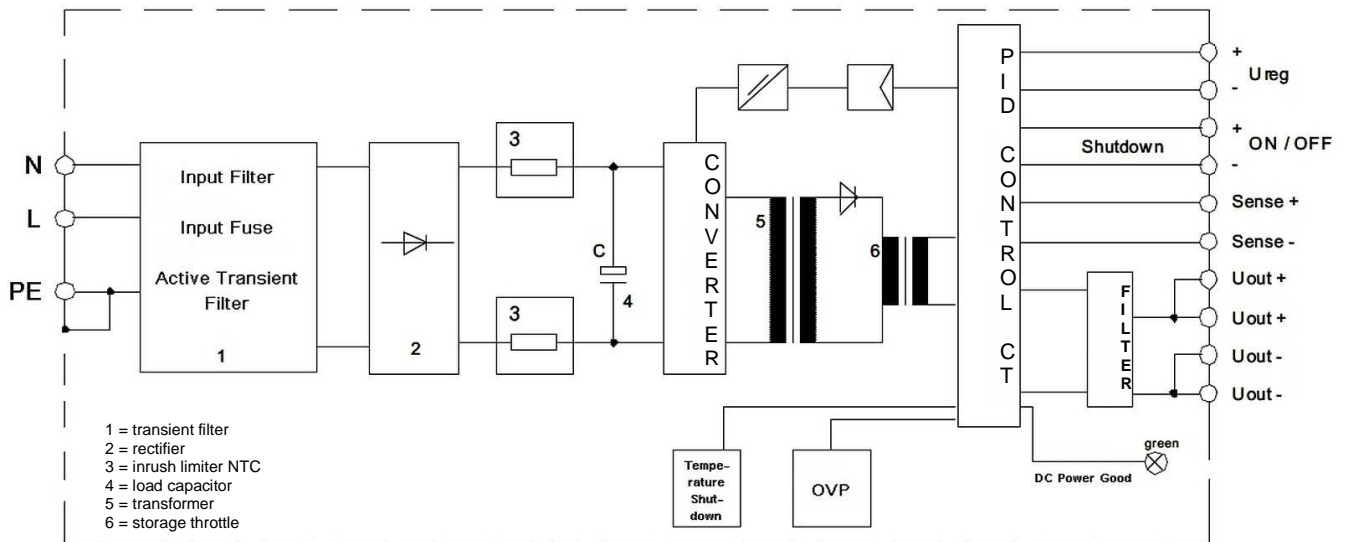

Technical Description

The HSEUreg-Series is a programmable switch mode power supply. Engineered and manufactured in by CAMTEC in Germany, it is designed for challenging applications like railway, drives, test-stands and machine-building. The HSEUreg provides a low Ripple-Noise, good Load-Regulation and high efficiency >90% (typ. @ 230Vac). High-end long life capacitors guarantee Hold-up-Time and extended lifetime of the power supply. Our HSEUreg-design starts complex loads easily. The internal control manages illegal operating conditions to prevent your system from failures. All HSEUreg power supplies are idling-proof and short circuit protected. Supply units of the same type and output voltage feature parallel or series operation.

The HSEUreg also features active high input transients with suppressor diodes, X2-capacitors and varistors. The design rules set value on extended interference immunity and safety. The PSU is engineered in accordance to EN60950-1 and EMC-compatibility to EN55022 class B.

Series Connection (fig.1)

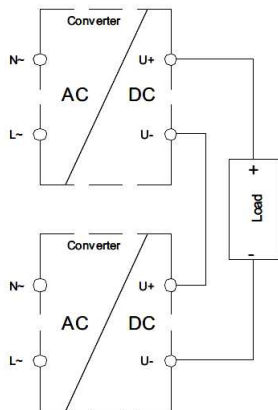

Parallel Connection (fig.2)

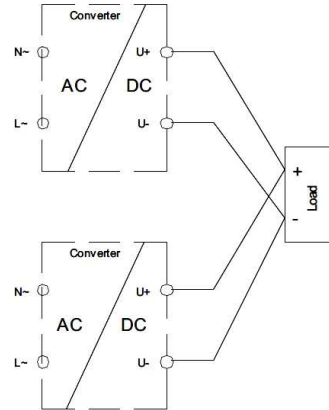

Series Connection (fig.1)

To increase output voltage equal HSEUreg can be connected in series. The control I/O should be galvanic insulated in the series mode. If not the minus main output is connected to the control I/O. Use our external option Isolating Transformer ADTW201 being validated with the HSEUreg. Be aware of safety norms if your target output voltage exceeds safety voltage.

Parallel Connection (fig.2)

To increase the output power up to 3 HSEUreg can be parallel connected. Advise using busbars to connect HSEUreg in parallel. Always use identical length and identical cross sections to the busbar.

ADTW201 Isolating Transformer (option)

The isolating transformer is used to galvanic isolate impressed current. The device is self powered. The input to output ratio is 1:1.

| Technical Information ADTW201 external DC-Repeater | |
|--|---------------------------------------|
| Input (Ie) | 0...20mA, 4...20mA (max. 50mA) |
| Voltage drop (Uw) | Uw>1.5V (Ie=20mA) |
| Max. apparent ohmic resistance (Ra) | 500R @ Ie=20mA |
| Input Impedance (R) | R=Ra+Uw/Ie |
| Barrier Frequency (Fa) | Fa=5kHz (-3dB) with Ra=500R @ Ie=20mA |
| Output | 1:1 |
| Ripple / Noise | >0,5% with 20mA and Ra=500R |
| Linear Failure | >0,03% / 100R |
| Transient oscillation current | 35uA |
| Latency | 150us 0..20mA, Ra=500R, 10...90% |
| Isolation Voltage Input/output | 500V |
| Operation Temperature | 0...50°C |
| Temperature Drift | Approx. 15ppm/K |
| Weight | 21g |
| Ordering Information | Part No: 304.1090.001CA |

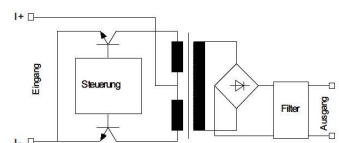
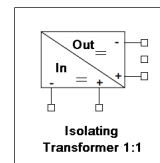

Coating Option

We offer the USEUreg-series with optional coating. It is to be used in e.g. dusty, dirty, high humidity, or in awaiting quick temperature changes. Short circuit and corrosion at print board lines and at solder points can be prevented. The coat itself is a transparent acrylic resin. It is procured with a robotics varnishing machine.

Peters SL 1306 N-FLZ (transparent) IEC60216-1 2001, IPC-CC-830B, UL listed as permanent coating FileNo.: E80315, UL94V-0

Ordering Information: ad extension C to the complete type number: HSEUreg04801.180TC or HSEUreg04801T420C

| Test | Time | A | B | C | D |
|--------------|------|---------|---------|--------|--------|
| Type Test | 60s | 2500Vac | 3000Vac | 500Vdc | 500Vdc |
| Factory Test | 5s | 2000Vac | 2000Vac | 500Vdc | 500Vdc |
| Field Test | 2s | 2000Vac | 2000Vac | 500Vdc | 500Vdc |

Type test and factory tests are conducted by the manufacturer. Do not repeat the test in field. Field test rules:

- Use appropriate test equipment which apply the voltage with a slow ramp
- Connect L1 and N together, as well as all output poles
- Use only AC test-voltages with 50/60Hz. The output voltages is floating and has no ohmic reference to ground.
- If testing output voltages are $\geq 60Vdc$ remain to security directives. Use only isolated screw drivers to adjust output voltages.

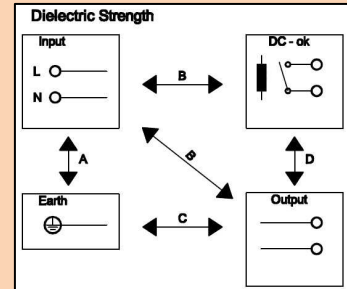

Terminal Connects:

AC Main Input

GND common
N - wire
L - wire

DC Mains Outputs

DC + voltage
DC + voltage
DC - voltage
DC - voltage

Inputs/Outputs

Ureg = programmable voltage input
Ureg = programmable current input
SD = shut down input
Sense = Sensing (compensation: 2V)

Mechanics & Installation of the HSEUreg

Stable metal/aluminium housing IP20. To allow adequate convection, a free air space of 50mm (top/bottom) and 5mm (sidewalls) is required; for active devices 15mm space from the sidewalls. For free air convection it is necessary to install the HSEUreg horizontal. You can use the DIN-Rail installation (equiped standard) with our patented 35mm DIN-Rail bracket according to EN60275. It is easy to mount/dismount while snapping it onto the 35mm DIN-Rail - any tools necessary. A wallmount backplate (option) is available, too

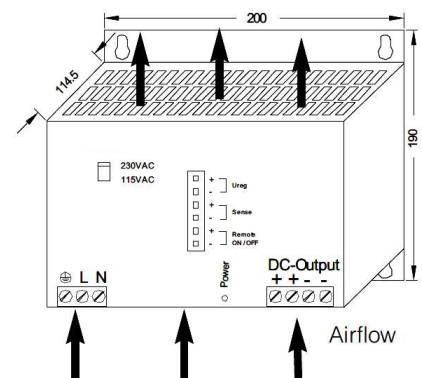
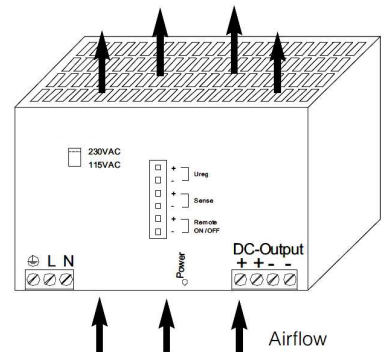
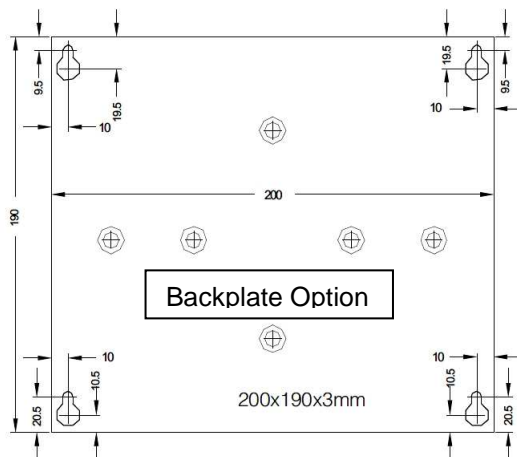
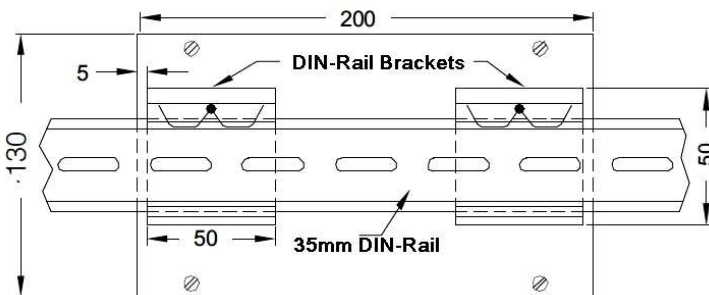

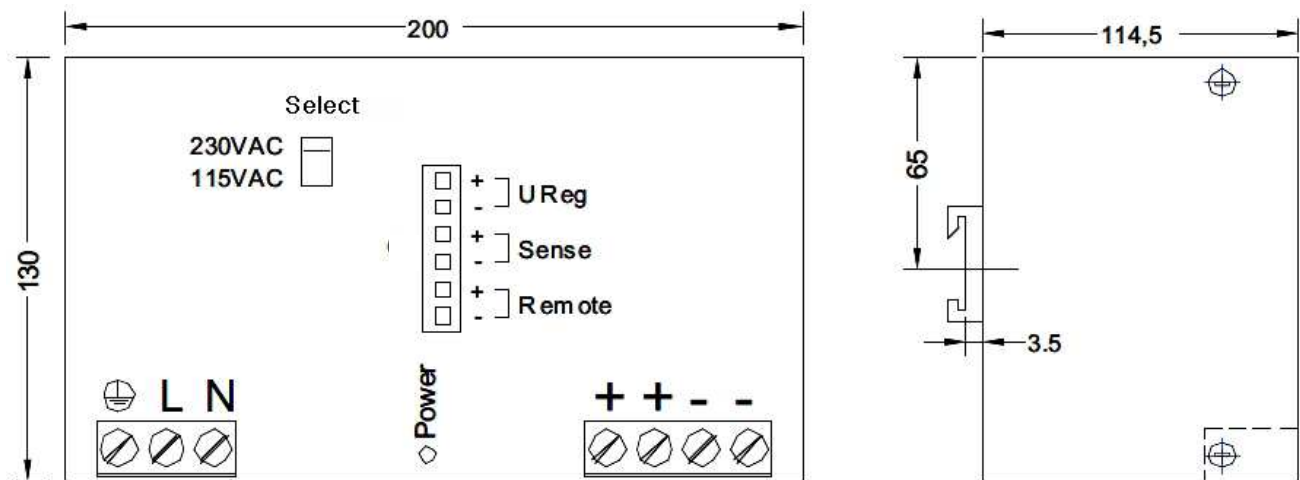

Safety Instructions: Please read all warnings and advices carefully before installing or operating the HSEUreg. Retain this operation manual always ready to hand. The HSEUreg must be installed by specialist staff only.

Installation:

- 1.) The HSEUreg is designed for systems fulfilling the safety norms of dangerous voltages/energy and fire prevention
- 2.) Installation is restricted to specialists only, make sure that the AC wire system is free of voltage
- 3.) Opening the HSEUreg, making any modifications to it, dismantling any screws from it, operating the HSEUreg out of specification and/or using it in appropriate area will inevitably result in losing manufactureres guarantee; we decline taking any responsibility for risk of damages caused to someones health or to any installed system.
- 4.) Attention: The HSEUreg has an internal input fuse. It is necessary to wire an automatic circuit braker to the line. We suggest to use a 16A-type with B-characteristic. It is verboten to operate the HSEUreg without protective earth wired. It essential to install a line switch before the HSEUreg.

Warnings:

Disregard these warnings can cause fire, electric shock, serious accident and death.

1. Never operate the HSEUreg without Protective Earth Conductor
2. Before connecting the HSEUreg to the AC wire system make all wires free of voltage and assure accidently switch on
3. Allow neat and professional cabeling
4. Never open nor try to repair the HSEUreg by yourself. Inside are dangerous voltages that can cause electric shock hazard.
5. Avoid metal pieces or other conductive material to fall into the HSEUreg
6. Do not operate the HSEUreg under damp or wet conditions
7. It is verboten to operate the HSEUreg under Ex conditions or in Ex-Area 

All parameters base on 5 minutes run-in @ full load / 25°C / 230Vac 50/60Hz, as otherwise stated.