

**meister**  
**strömungstechnik** gmbh

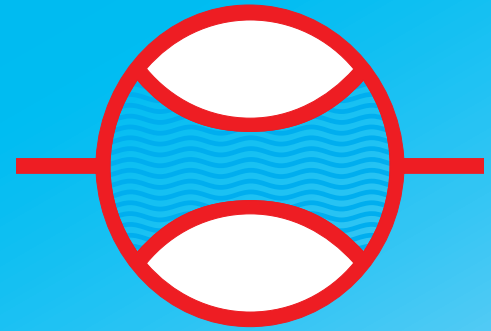

## Product Overview 2004

Use the buttons at the bottom of the screen to navigate  
To close the catalog click the button at the product index

INDEX

# INDEX

- 1**      **Product overview / Index**
- 2**      **Flow monitors and indicators with sight glass**  
DWG, DWG-L, DUG, RVO/U, RVO/U-L
- 3**      **Flow monitors and indicators fullmetal version**  
DWM/A, DWM/A-L, DWM, DWM-L, DUM/A, DUM, RVM/U, RMV/U-L,  
RVM/UM, RMU, SC-250
- 4**      **Flow monitors and indicators for oil, viscosity compensated**  
DKG, DKM/A, DKME/A, DKM, DKME
- 5**      **Plastic-flowmeters and monitors**  
KM 10 - KM 13, KM 16 - KM 20, KM 35, RVP/U
- 6**      **Flow sensors with impeller or turbine**  
DHGF, DHSF, DIGA, DOSF/L, DOGF/L, DHTF, DHTA, FRA, FAA
- 7**      **[UNDER CONSTRUCTION]**
- 8**      **Paddle flow monitors, Baffle plate flowmeter**  
SPM, SPM-L, DP
- 9**      **Flow limiter**  
BA, BB, BC
- 10**      **Accessories and electronic modules**  
VSB, NV, SF, SFD, SFM, ATD, KSR
- 11**      **Technical information**  
**[UNDER CONSTRUCTION]**



Flow monitors and flow indicators with sight glass for liquids and gases

Types: **DWG**, **DWG-L**, **DUG**, **RVO/U**, **RVO/U-L**

**DWG**



**Flow monitor and indicator for liquids**

- large measuring range
- sturdy construction
- high switch accuracy

**DWG-L**



**Flow monitor and indicator for gases**

- large measuring range
- sturdy construction
- high switch accuracy

**DUG**



**Flow monitor and indicator for liquids**

- large measuring range
- sturdy construction
- installation in any orientation
- high switch accuracy

**RVO/U**



**Flow monitor and indicator for liquids**

- small physical size
- sturdy construction
- installation in any orientation

**RVO/U-L**



**Flow monitor and indicator for gases**

- small physical size
- sturdy construction
- installation in any orientation

# Flow Monitor Flow Indicator

## DWG



### Operation

The flow monitors and indicators type DWG operate with the float measuring principle



### Application

The flow monitors and indicators type DWG are used for indicating and monitoring volumeflow of liquid media.

Areas of application:

- Coolingsystems and cooling-circuits
- Mechanical Engineering e.g. Weldingmachinery and Laserplants
- Medicine technology
- Pharma industry
- Chemical industry
- Research and development

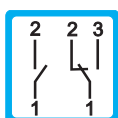
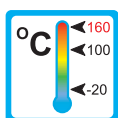

### Features

The DWG series proves itself through reliable function and easy handling. Further characteristics of this sturdy type are:

- high reliability
- high switch accuracy
- wide switch range
- infinitely variable switchpoint adjustment through user
- EX-version to ATEX available
- Scales are burned into the sightglass
- Threaded connection  
Special threads on request

### Installation hints

The instrument must be installed vertically in the system. The flow direction is from bottom to top.

The flow monitor must not be used as a supporting part in a pipeconstruction!

The medium must not contain any solid particles! We recommend the installation of strainer type SFD or SFM.

External magnetic fields influence the switch contact. Keep adequate distance to those magnetic fields (e.g. electromotors)!

The operating instruction for DWG must be observed under any circumstances!

DWG 1 0002 08-04 E M

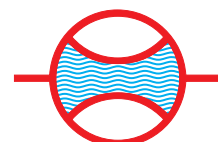



# Measuring Ranges, Technical Data

## Connection diagram

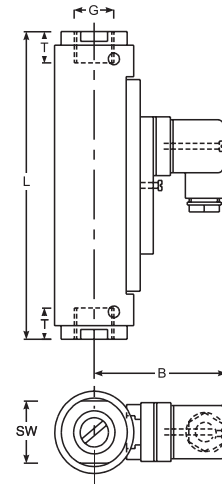
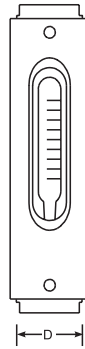
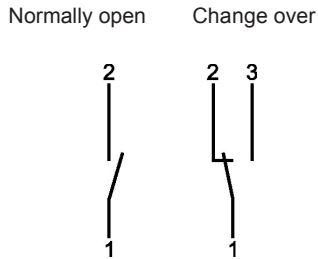

## Summary of types DWG

Type	Switch range* H <sub>2</sub> O [l/min]	Overall dimensions mm							Weight approx. [g]
		SW	D	B	G	DN	T	L	
DWG - 1,5	0,1 - 1,5	32	43	73	1/4"	8	14	132	625
DWG - 3	0,2 - 3,0				3/8"	10	14	135	
DWG - 8	0,3 - 8,0				1/2"	15	15	135	
DWG - 12	1 - 12	32	43	73	1/2"	15	15	163	650
DWG - 18	2 - 18				3/4"	20	16	167	
DWG - 35	3 - 35	41	50	76	3/4"	20	18	164	850
DWG - 50	4 - 50				1"	25	19	184	

\* Other media on request

Operating data		DWG	
Operating pressure:		PN 10 bar	
Pressure drop:		0,01 - 0,2 bar	
Maximum temperature:		100 °C (optional 160 °C)	
Accuracy:		± 5% of full scale	
Electrical data		Normally open	Change over
IP 65 (plug connection DIN 43650)		max. 250V • 3A • 100VA	max. 250V • 1,5A • 50VA
IP 67 (1m sealed in cable)			
Atex II 2G EEx m II T6 (2m sealed in cable)		max. 250V • 2A • 60VA	max. 250V • 1A • 30VA
EEx m II T6 (2m sealed in cable)		max. 250V • 2A • 60VA	max. 250V • 1A • 30VA
EEx ia IIC T6 (2m sealed in cable)		max. 45V • 1A	max. 45V • 1A
Output signal:		The contact opens / changes, when the flow falls below the set point.	
Power supply:		Not required (potentialfree reed contacts)	
Other plug type or cable length on request			
Material		Brass	Stainless Steel
Wetted parts:		Brass nickel-plated	1.4571
Float: (wetted part)		Brass nickel-plated	1.4571
Sight glass: (wetted part)		Duran 50	
Gaskets: (wetted part)		Perbunan (optional Viton, EPDM) *	Viton (optional Perbunan, EPDM) *
Housing: (non wetted part)		Aluminium anodized	

\* Other gasket materials on request

DWG 2 0006 08-04 E.M



# Flow Monitor Flow Indicator

## DWG-L



### Operation

The flow monitors and indicators type DWG-L operate with the float measuring principle



### Application

The flow monitors and indicators type DWG-L are used for indicating and monitoring volumeflow of gaseous media.

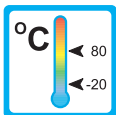

Areas of application for example:



– Coolingsystems and cooling-circuits



– Mechanical Engineering e.g. Weldingmachinery and Laserplants

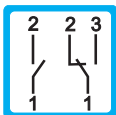

– Medicine technology

– Pharma industry

– Chemical industry



– Research and development



### Features

The DWG-L series proves itself through reliable function and easy handling. Further characteristics of this sturdy type are:

- high reliability
- high switch accuracy
- wide switch range
- infinitely variable switchpoint adjustment through user
- EX-version to ATEX available
- Scales are burned into the sightglass
- Threaded connections special threads on request

### Installation hints

The instrument must be installed vertical in the system. The flow direction is from bottom to top.

The flow monitor must not be used as a supporting part in a pipeconstruction!

The medium must not contain any solid particles! We recommend the installation of strainer type SFD or SFM.

External magnetic fields influence the switch contact. Keep adequate distance to those magnetic fields (e.g. electromotors)!

The operating instruction for DWG-L must be observed under any circumstances!

DWG-L 1 0001 05-04 E M



# Measuring Ranges, Technical Data

## Connection diagram

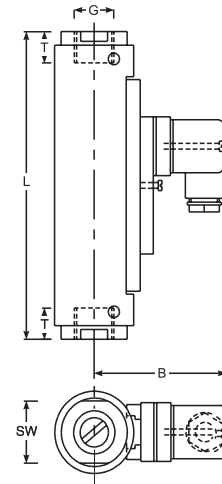
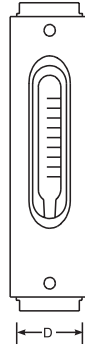
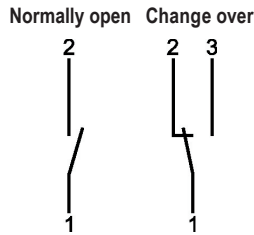

## Summary of types DWG-L

Type	Switch range* NI/min Air	SW	Overall dimensions mm						Weight approx. [g]
			D	B	G	DN	T	L	
DWG-L1,5	3 - 30	32	43	73	1/4"	8	14	132	625
DWG-L3	6 - 60				3/8"	10	14	135	
DWG-L8	6 - 160				1/2"	15	15	135	
DWG-L12	20 - 220				1/2"	15	15	135	
DWG-L18	40 - 360	32	43	73	1/2"	15	15	163	650
DWG-L35	60 - 700	41	50	76	3/4"	20	18	164	
DWG-L50	60 - 825				1"	25	19	184	1000
DWG-L100	200 - 1600				1"	25	19	204	1100

\* At 1 bar abs. and 20 °C, other media and/or working conditions on request

Operating data:		DWG-L	
Operating pressure:		PN 10 bar	
Pressure drop:		0,01 - 0,2 bar	
Maximum temperature:		80 °C	
Accuracy:		± 10% of final value	
Electrical data:		Normally open	Change over
IP 65 (plug connection DIN 43650)		max. 250V • 3A • 100VA	max. 250V • 1,5A • 50VA
IP 67 (with 1m sealed in cable)			
Atex II 2G EEx m II T6 (with 2m sealed in cable)		max. 250V • 2A • 60VA	max. 250V • 1A • 30VA
EEx m II T6 (with 2m sealed in cable)		max. 250V • 2A • 60VA	max. 250V • 1A • 30VA
EEx ia IIC T6 (with 2m sealed in cable)		max. 45V • 1A	max. 45V • 1A
Output signal:	The contact opens / changes, when the flow falls below the set point		
Powersupply:	Not required (potentialfree reed contacts)		
Other plug-types or cable length on request			
Material:		Brass	Stainless steel
Wetted parts:		Brass nickel-plated	1.4571
Float:	(wetted part)	Delrin	
Sight glass:	(wetted part)	Duran 50	
Gaskets:	(wetted part)	Perbunan (optional Viton, EPDM) *	Viton (optional Perbunan, EPDM) *
Housing:	(non wetted part)	Aluminium anodised	

\* Other gasket materials on request

DWG-L-2 0005 05-04 E.M



# Flow monitor Flow indicator

## DUG



### Operation

The flow monitors and indicators type DUG operate with the float measuring principle



### Application

The flow monitors and indicators type DUG are used for measuring and monitoring volumeflow of liquid media.

Areas of application:

- Coolingsystems and cooling-circuits
- Mechanical Engineering e.g. Weldingmachinery, Laserplants
- Medicine technology
- Pharma industry
- Chemical industry
- Research and development

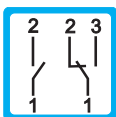
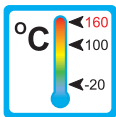

### Features

The DUG series proves itself through reliable function and easy handling. Further characteristics of this sturdy type are:

- universal mounting
- high switch accuracy
- wide switch range
- infinitely variable switchpoint adjustment through user
- EX-version to ATEX available
- Scales are burned into to the sightglass
- Threaded connection  
Special threads on request

### Installation hints

The installation of the flow monitor can be done in any way in the system. The flow direction must be observed.

The flow monitor must not be used as a supporting part in a pipeconstruction!

The medium must not contain solid particles!  
We recommend the installation of strainers type SFD or SFM.

External magnetic fields influence the switch contact. Keep adequate distance to those magnetic fields (e.g. electromotors)!

The operating instruction for DUG must be observed under any circumstances!

DUG 1 0001 09-04 E M



# Measuring Ranges, Technical Data

## Connection diagram

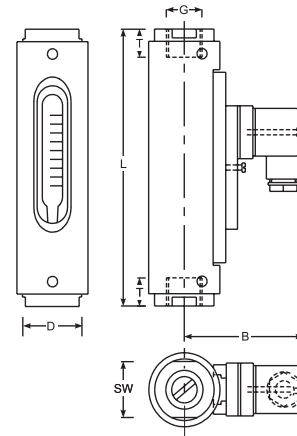
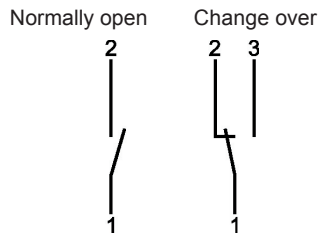

## Summary of types DUG

Type	Switch range* H <sub>2</sub> O [l/min]	Overall dimensions mm							Weight approx. [g]
		SW	D	B	G	DN	T	L	
DUG - 4	0,2 - 4	32	43	73	1/4"	8	14	132	625
DUG - 6	0,5 - 6				3/8"	10	14	132	
DUG - 8	0,5 - 8				1/2"	15	15	135	
DUG - 14	0,5 - 14				1/2"	15	15	135	
DUG - 22	2 - 22	32	43	73	1/2"	15	15	135	650
DUG - 28	1 - 28								
DUG - 45	2,5 - 45	32	43	73	3/4"	20	18	167	850
DUG - 80	2 - 80								
DUG - 90	6 - 90	41	50	76	1"	25	19	184	1000
DUG - 110	6 - 110								
DUG - 150	15 - 150	50	55	79	1 1/4"	32	21	216	1300
DUG - 220	30 - 220	55	60	81	1 1/4"	32	21	210	1700
DUG - 250	35 - 250	50	55	79	1 1/4"	32	21	222	1400

\* Other media on request

Operating data		DUG	
Operating pressure:		PN 10 bar	
Pressure drop:		0,02 - 0,8 bar	
Maximum temperature:		100 °C (optional 160 °C)	
Accuracy:		± 5% of full scale	
Electrical data		Normally open	Change over
IP 65 (plug connection DIN 43650)		max. 250V • 3A • 100VA	max. 250V • 1,5A • 50VA
IP 67 (1m sealed in cable)			
Atex II 2G EEx m II T6 (2m sealed in cable)		max. 250V • 2A • 60VA	max. 250V • 1A • 30VA
EEx m II T6 (2m sealed in cable)		max. 250V • 2A • 60VA	max. 250V • 1A • 30VA
EEx ia IIC T6 (2m sealed in cable)		max. 45V • 1A	max. 45V • 1A
Output signal:		The contact opens / changes, when the flow falls below the set point.	
Power supply:		Not required (potentialfree reed contacts)	
Other plug types or cable lengths on request			
Material		Brass	Stainless Steel
Wetted parts:		Brass nickel-plated	1.4571
Spring:	(wetted part)	1.4571	1.4571
Sight glass:	(wetted part)	Duran 50	
Gaskets:	(wetted part)	Perbunan (optional Viton, EPDM) *	Viton (optional Perbunan, EPDM) *
Housing:	(non wetted part)	Aluminium anodized	

\* Other gasket materials on request

DUG 2 0007 09-04 E.M



# Flow Monitor Flow Indicator

## RVO/U



### Operation

The flow monitors and indicators type RVO/U operate with the float measuring principle



### Application

The flow monitors and indicators type RVO/U are used for indicating and monitoring volumeflow of liquid media.

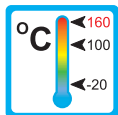

Areas of application:

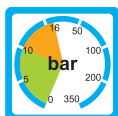

– Coolingsystems and cooling-circuits



– Mechanical Engineering  
e.g. Weldingmachinery  
and Laserplants

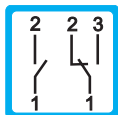

– Medicine technology

– Pharma industry

– Chemical industry



– Research and development



### Features

The RVO/U series proves itself through reliable function and easy handling. Further characteristics of this sturdy type are:

- universal orientation
- high switch accuracy
- infinitely variable switchpoint adjustment through user
- EX-version to ATEX for RVO/U-1... available
- Scales are burned into the sightglass
- Threaded connection  
Special threads on request

### Installation hints

The installation of the flow monitor can be done in any way in the system. The flow direction must be observed.

The flow monitor must not be used as a supporting part in a pipeconstruction!

The medium must not contain any solid particles!  
We recommend the installation of strainers type SFD or SFM.

External magnetic fields influence the switch contact. Keep adequate distance to those magnetic fields (e.g. electromotors)!

The operating instruction for RVO/U must be observed under any circumstances!

RVO/U 1 0002 10-04 E M



# Measuring Ranges, Technical Data

## Connection diagram:

Normally open

Change over:

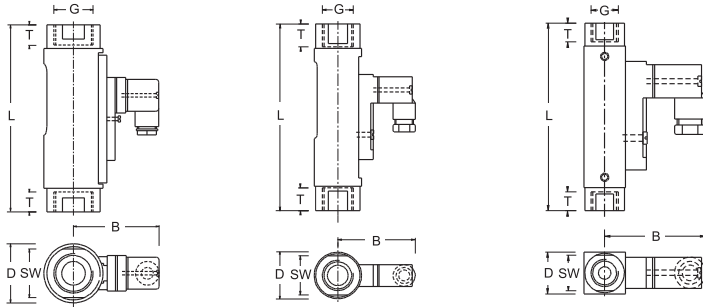
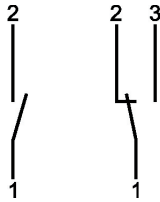

## Summary of types RVO/U

Type	Switch range* l/min H <sub>2</sub> O	Overall dimensions mm							Weight approx. [g]
		SW	D	B	G	DN	T	L	
RVO/U-4/01	0,005 - 0,06	17	20	49	1/4"	8	10	90	140
RVO/U-4/02	0,02 - 0,14								
RVO/U-4/06	0,1 - 0,6								
RVO/U-4/1	0,2 - 1,2								
RVO/U-4/2	0,4 - 2,0								
RVO/U-4/3	0,5 - 3,0								
RVO/U-4/5	1,0 - 5,0	27	32	53	1/2"	15	14	114	300
RVO/U-2/05	0,1 - 0,5								
RVO/U-2/1	0,2 - 1								
RVO/U-2/2	0,4 - 1,6								
RVO/U-2/4	1 - 4								
RVO/U-2/8	2 - 8								
RVO/U-2/15	4 - 15	41	50	77	3/4"	20	18	139	800
RVO/U-2/20	5 - 22								
RVO/U-2/28	6 - 28								
RVO/U-1/30	8 - 30								
RVO/U-1/45	15 - 45								
RVO/U-1/90	30 - 90								
RVO/U-1/150	60 - 150	41	50	77	1"	25	18	158	900

\* Other switch ranges on request

Operating data	RVO/U-1	RVO/U-2	RVO/U-4
Operating pressure:	PN 10 bar	PN 10 bar	PN 16 bar
Pressure drop:	0,02 - 0,4 bar	0,02 - 0,3 bar	0,02 - 0,2 bar
Maximum temperature:	100 °C (optional 160 °C)		
Accuracy:	±10% of full scale		
Electrical data			
Normally open:	max. 250V • 3A • 100VA	max. 230V • 3A • 60VA	max. 200V • 1A • 20VA
Change over:	max. 250V • 1,5A • 50VA	max. 250V • 1,5A • 50VA	max. 200V • 1A • 20VA
Atex II 2G EEx m II T6 (only for RVO/U-1)	Change over: 250V • 1A • 30VA, IP67 / Normally open: 250V • 2A • 60 VA, IP67		
EEx m II T6 (only for RVO/U-1)	Change over: 250V • 1A • 30VA, IP67 / Normally open: 250V • 2A • 60 VA, IP67		
EEx ia IIC T6 (only for RVO/U-1)	Change over / Normally open: 45V • 1A, IP67		
Ingress Protection:	IP65 (plug connection DIN 43650 Form A or C) IP67 (1m sealed in cable, with EEx-version 2 m)		
Output signal:	The contact opens / changes, when the flow falls below the set point.		
Power supply:	Not required (potentialfree reed contacts)		

other plug types or cable lengths on request

Material	Brass	Stainless Steel
Wetted parts:	Brass nickel-plated	1.4571
Sight glass: (wetted part)	Duran 50	Duran 50
Spring: (wetted part)	1.4571	1.4571
Gaskets: (wetted part)	Perbunan (optional Viton, EPDM)*	Viton (optional Perbunan, EPDM)*
Magnets: (wetted part)	Hardferrit	Hardferrit
Housing: (non wetted part)	Aluminium anodized	Aluminium anodized

\* Other gasket materials on request





# Flow Monitor Flow Indicator

## RVO/U-L



### Operation

The flow monitors and indicators type RVO/U-L operate with the float measuring principle



### Application

The flow monitors and indicators type RVO/U-L are used for indicating and monitoring volumeflow of gaseous media.

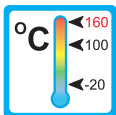

Areas of application for example:



– Coolingsystems and cooling-circuits



– Mechanical Engineering  
e.g. Weldingmachinery  
and Laserplants

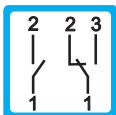

– Medicine technology

– Pharma industry

– Chemical industry



– Research and development



### Features

The RVO/U-L series proves itself through reliable function and easy handling. Further characteristics of this sturdy type are:

- universal mounting
- high reliability
- high switch accuracy
- infinitely variable switchpoint adjustment through user
- EX-version to ATEX for RVO/U-L1... available
- Scales are burned into the sight glass
- Threaded connections special threads on request

### Installation hints

The installation of the flow can be done in any way in the system. The flow direction must be observed.

The flow monitor must not be used as a supporting part in a pipeconstruction!

The medium must not contain any solid particles! We recommend the installation of strainers type SFD or SFM.

External magnetic fields influence the switch contact. Keep adequate distance to those magnetic fields (e.g. electromotors)!

The operating instruction for RVO/U-L must be observed under any circumstances!

RVO/U-L 1 0001 05-04 E M





# Measuring Ranges, Technical Data

## Connection diagram

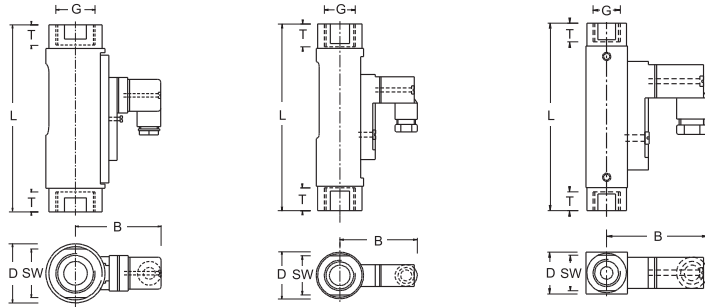
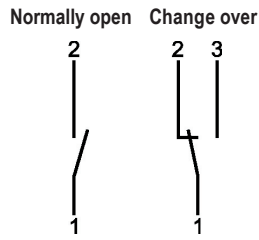

## Summary of types RVO/U-L

Type	Switch range* NI/min Air	Overall dimensions mm							Weight approx. [g]								
		SW	D	B	G	DN	T	L									
RVO/U-L40001	0,2 - 1,3	17	20	49	1/4"	8	10	90	140								
RVO/U-L40002	0,5 - 2																
RVO/U-L40003	0,8 - 3																
RVO/U-L40005	1,5 - 5																
RVO/U-L40008	2 - 8																
RVO/U-L40012	3 - 12																
RVO/U-L40014	3,5 - 14																
RVO/U-L40020	5,5 - 20																
RVO/U-L40024	7 - 24																
RVO/U-L40035	10 - 35																
RVO/U-L40042	10 - 42	27	32	53	1/2"	15	14	114	300								
RVO/U-L20012	3 - 12																
RVO/U-L20030	7 - 30																
RVO/U-L20040	12 - 40																
RVO/U-L20125	28 - 125																
RVO/U-L20200	50 - 200																
RVO/U-2/15L	100 - 420																
RVO/U-2/20L	120 - 480																
RVO/U-L10080	22,5 - 80									41	50	77	3/4"	20	21	139	800
RVO/U-L10130	50 - 130																
RVO/U-L10420	130 - 420																
RVO/U-L10625	200 - 625																
					1"	25	17	158	900								

\* At 1 bar abs. and 20 °C, other switch ranges on request

Operating data:	RVO/U-L1	RVO/U-L2	RVO/U-L4
Operating pressure:	PN 10 bar	PN 10 bar	PN 16 bar
Pressure drop:	0,02 - 0,4 bar	0,02 - 0,3 bar	0,02 - 0,2 bar
Maximum temperature:	100 °C (optional 160 °C)		
Accuracy:	±10% of full scale		
Electrical data:			
Normally open:	max. 250V • 3A • 100VA	max. 230V • 3A • 60VA	max. 200V • 1A • 20VA
Change over:	max. 250V • 1,5A • 50VA	max. 250V • 1,5A • 50VA	max. 200V • 1A • 20VA
Atex II 2G EEx m II T6 (only for RVO/U-L1)	Change over: 250V • 1A • 30VA, IP67 / Normally open: 250V • 2A • 60 VA, IP67		
EEx m II T6 (only for RVO/U-L1)	Change over: 250V • 1A • 30VA, IP67 / Normally open: 250V • 2A • 60 VA, IP67		
EEx ia IIC T6 (only for RVO/U-L1)	Change over / Normally open: 45V • 1A, IP67		
Protection type:	IP65 (plug connection DIN 43650 Form A or C) IP67 (1m sealed in cable, with EEx-version 2m)		
Output signal:	The contact opens / changes, when the flow falls below the set point		
Powersupply:	Not required (potentialfree reed contacts)		
Other plug-types or cable length on request			
Material:	Brass	Stainless Steel	
Wetted parts:	Brass nickel-plated	1.4571	
Sight glass: (wetted part)	Duran 50	Duran 50	
Spring: (wetted part)	1.4571	1.4571	
Gaskets: (wetted part)	Perbunan (optional Viton, EPDM)*	Viton (optional Perbunan, EPDM)*	
Magnets: (wetted part)	Hartferrit	Hartferrit	
Housing: (non wetted part)	Aluminium anodised	Aluminium anodised	

\* Other gasket materials on request



Flow monitors and flow indicators in fullmetal version for liquids and gases

Types: DWM/A, DWM/A-L, DWM, DWM-L, DUM/A, DUM, RVM/U, RVM/U-L, RVM/UM

**DWM/A**



**Flow monitor and indicator for liquids**

- large measuring range
- sturdy construction
- high operating pressure
- high switch accuracy

**DWM/A-L**



**Flow monitor and indicator for gases**

- large measuring range
- sturdy construction
- high operating pressure
- high switch accuracy

**DWM**



**Flow monitor for liquids**

- large switch range
- sturdy construction
- high operating pressure
- high switch accuracy

**DWM-L**



**Flow monitor for gases**

- large switch range
- sturdy construction
- high operating pressure
- high switch accuracy

**DUM/A**



**Flow monitor and indicator for liquids**

- large measuring range
- sturdy construction
- high operating pressure
- installation in any orientation

**DUM**

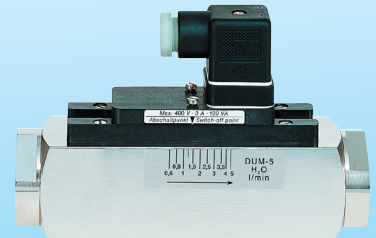

**Flow monitor for liquids**

- large switch range
- sturdy construction
- high operating pressure
- installation in any orientation

**RVM/U**



**Flow monitor for liquids**

- small physical size
- sturdy construction
- installation in any orientation

**RVM/U-L**



**Flow monitor for gases**

- small physical size
- sturdy construction
- installation in any orientation

**RVM/UM**



**Flow monitor for liquids**

- low switchpoint at high flowrate
- sturdy construction
- installation in any orientation

Flow monitors and flow indicators in fullmetal version  
Types: **RMU**, **SC**

**RMU**

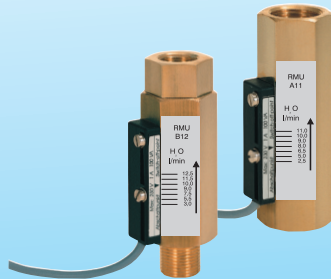

**Flow monitor for liquids**

- small physical size
- sturdy construction
- low sensitivity to dirt

**SC**



**Flowmeter for liquids and gases**

- high accuracy
- product specific scale
- nominal size up to DN 150
- several options

# Flow Monitor Flow Indicator

## DWM/A

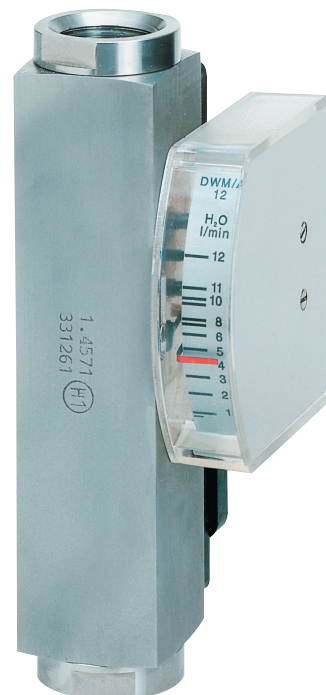

### Operation

The flow monitors and indicators type DWM/A operate with the float measuring principle



### Application

The flow monitors and indicators type DWM/A are used for measuring and monitoring volumeflow of liquid media.

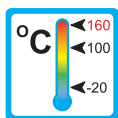

Areas of application:



– Coolingsystems and cooling circuits



– Mechanical Engineering e.g. Weldingmachinery, Laserplants

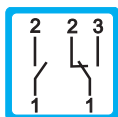

– Medicine technology

– Pharma industry



– Chemical industry



– Research and development



### Features

The DWM/A series proves itself through reliable function and easy handling

- high reliability
- high switch accuracy
- wide switch range
- infinitely variable switchpoint adjustment through user
- EX-version to ATEX available
- high pressure resistance
- Threaded connection  
Special threads on request

### Installation hints

The instrument must be installed vertically in the flow circuit. The flowdirection is from bottom to top.

The flow monitor must not be used as a supporting part in a pipeconstruction!

The medium must not contain any solid particles!  
We recommend the installation of strainers type SFD or SFM.

External magnetic fields influence the switch contact. Keep adequate distance to those magnetic fields (e.g. electromotors)!

The operating instruction for DWM/A must be observed under any circumstances!

DWM/A 1 0002 08-04 E M



# Measuring Ranges, Technical Data

## Connection diagram:

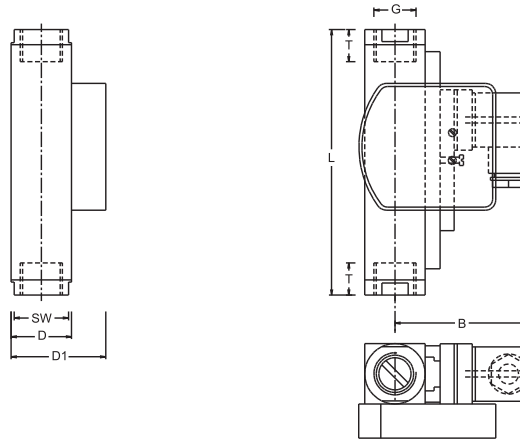
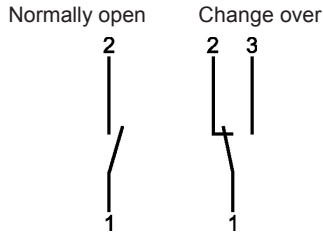

## Summary of types DWM/A

Typ	Switch range* H <sub>2</sub> O [l/min]	Overall dimensions mm								Weight approx. [g]
		SW	D	D1	B	G	DN	T	L	
DWM/A - 1,5	0,1 - 1,5	27	30	47	71	1/4"	8	14	131	850
DWM/A - 3	0,2 - 3					3/8"	10	19		
DWM/A - 8	0,3 - 8					1/2"	15	19		
DWM/A - 12	1 - 12	27	30	47	71	1/2"	15	19	148	850
DWM/A - 18	2 - 18	32	30	47	71	3/4"	20	17	174	1010
DWM/A - 35	3 - 35	34	40	57	76	3/4"	20	18	152	1500
DWM/A - 50	4 - 50	40	40	57	76	1"	25	19	156	1500

\* Other media on request

Operating data		DWM/A	
Operating pressure:		PN 200 bar (Brass)	PN 300 bar (Stainless Steel)
Pressure drop:		0,02 - 0,2 bar	
Maximum temperature:		100 °C (optional 160 °C)	
Accuracy:		± 5% of full scale	
Electrical data		Normally open	Change over
IP 65 (plug connection DIN 43650)		max. 250V • 3A • 100VA	max. 250V • 1,5A • 50VA
IP 67 (1m sealed in cable)			
Atex II 2G EEx m II T6 (2m sealed in cable)		max. 250V • 2A • 60VA	max. 250V • 1A • 30VA
EEx m II T6 (2m sealed in cable)		max. 250V • 2A • 60VA	max. 250V • 1A • 30VA
EEx ia IIC T6 (2m sealed in cable)		max. 45V • 1A	max. 45V • 1A
Output signal:		The contact opens / changes, when the flow falls below set point.	
Power supply:		Not required (potentialfree reed contact)	
Other plug types or cable lengths on request			
Material		Brass	Stainless Steel
Wetted parts:		Brass nickel-plated	1.4571
Float: (wetted part)		Brass nickel-plated	1.4571
Gaskets (wetted part)		Perbunan (optional Viton, EPDM)*	Viton (optional Perbunan, EPDM)*

\* Other gasket materials on request

DWM/A 2 0006 08-04 E M



# Flow Monitor Flow Indicator

## DWM/A-L

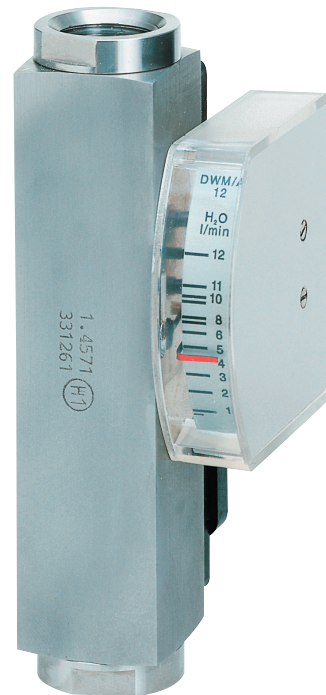

### Operation

The flow monitors and indicators type DWM/A-L operate with the float measuring principle



### Application

The flow monitors and indicators type DWM/A-L are used for measuring and monitoring volumeflow of gaseous media.

Areas of application:

- Coolingsystems and cooling-circuits
- Mechanical Engineering e.g. Weldingmachinery, Laserplants
- Medicine technology
- Pharma industry
- Chemical industry
- Research and development

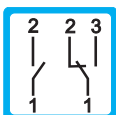
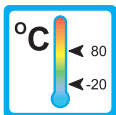

### Features

The DWM/A-L series proves itself through reliable function and easy handling. Further characteristics of this sturdy type are:

- high reliability
- high switch accuracy
- wide switch range
- infinitely variable switchpoint adjustment through user
- EX-version to ATEX available
- high pressure resistance
- Threaded connection  
Special threads on request

### Installation hints

The instrument must be installed vertically in the flow circuit. The flowdirection is from bottom to top.

The flow monitor must not be used as a supporting part in a pipeconstruction!

The medium must not contain any solid particles! We recommend the installation of strainers type SFD or SFM.

External magnetic fields influence the switch contact. Keep adequate distance to those magnetic fields (e.g. electromotors)!

The operating instruction for DWM/A-L must be observed under any circumstances!

DWM/A-L 1 0001 05-04 E M



# Measuring Ranges, Technical Data

## Connection diagram

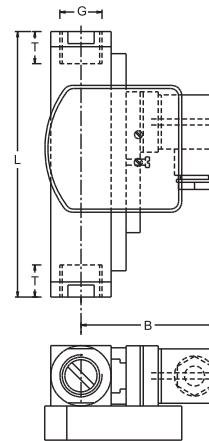
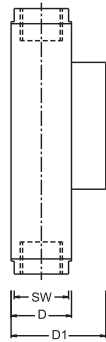
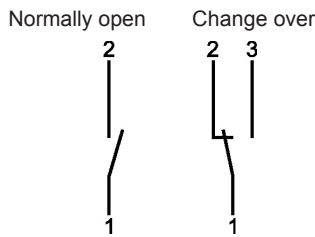

## Summary of types DWM/A - L

Type	Switch range* Air [NI/min]	Overall dimensions mm								Weight approx. [g]
		SW	D	D1	B	G	DN	T	L	
DWM/A - L1,5	1 - 28	27	30	47	71	1/4"	8	14	130	850
DWM/A - L3	4 - 60					3/8"				
DWM/A - L8	6 - 160					1/2"				
DWM/A - L12	20 - 240					1/2"				
DWM/A - L18	40 - 360	27	30	47	71	1/2"	15	19	148	900
						3/4"	20	17	152	1010
DWM/A - L35	60 - 700	34	40	57	76	3/4"	20	18	156	1400
DWM/A - L50	80 - 1000	40	40	57	76	1"	25	19	156	1100
DWM/A - L100	200 - 1400	50	50	67	81	1"	25	20	200	2800

\* at 1 bar abs. and 20 °C, other media and/or operating conditions on request

Operating data		DWM/A-L	
Operating pressure:		PN 200 bar (Brass)	PN 300 bar (Stainless steel)
Pressure drop:		0,02 - 0,4 bar	
Maximum temperature:		80 °C	
Accuracy:		± 10% of full scale	
Electrical data:		Normally open	Change over
IP 65 (plug connection DIN 43650)		max. 250V • 3A • 100VA	max. 250V • 1,5A • 50VA
IP 67 (1m sealed in cable)			
Atex II 2G EEx m II T6 (2m sealed in cable)		max. 250V • 2A • 60VA	max. 250V • 1A • 30VA
EEx m II T6 (2m sealed in cable)		max. 250V • 2A • 60VA	max. 250V • 1A • 30VA
EEx ia IIC T6 (2m sealed in cable)		max. 45V • 1A	max. 45V • 1A
Output signal:		The contact opens / changes, when the flow falls below set point.	
Power supply:		Not required (potentialfree reed contact)	
Other plug types or cable lengths on request			
Material:		Brass	Stainless steel
Wetted parts:		Brass nickel-plated	1.4571
Float:	(wetted part)	Delrin	
Gaskets:	(wetted part)	Perbunan (optional Viton, EPDM)*	Viton (optional Perbunan, EPDM)*

\* Other gasket materials on request

DWM/A-L 2 0005 05-04 E M





# Flow Monitor

## DWM



### Operation

The flow monitors type DWM operate with the float measuring principle



### Application

The flow monitors type DWM are used for monitoring volumeflow of liquid media

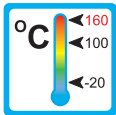

Areas of application:

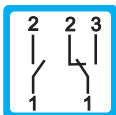

- Coolingsystems and cooling-circuits
- Mechanical Engineering e.g. Weldingmachinery, Laserplants
- Medicine technology
- Pharma industry
- Chemical industry
- Research and development

### Features

The DWM series proves itself through reliable function and easy handling. Further characteristics of this sturdy type are:

- high reliability
- high switch accuracy
- wide switch range
- infinitely variable switchpoint adjustment through user
- EX-version to ATEX available
- high pressure resistance
- Threaded connection  
Special threads on request

### Installation hints

The instrument must be installed vertically in the flow circuit. The flowdirection is from bottom to top.

The flow monitor must not be used as a supporting part in a pipeconstruction!

The medium must not contain any solid particles!  
We recommend the installation of strainers type SFD or SFM.

External magnetic fields influence the switch contact. Keep adequate distance to those magnetic fields (e.g. electromotors)!

The operating instruction for DWM must be observed under any circumstances!

DWM 1 0002 08-04 E M





# Measuring Ranges, Technical Data

## Connection diagram

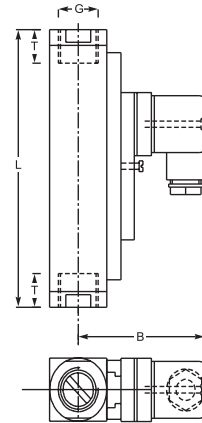
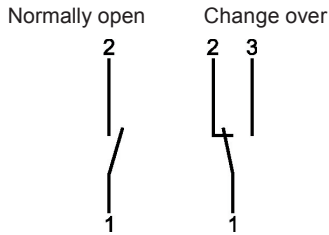

## Summary of types DWM

Type	Switch range* H <sub>2</sub> O [l/min]	Overall dimensions mm							Weight approx. [g]
		SW	D	B	G	DN	T	L	
DWM - 1,5	0,1 - 1,5	27	30	71	1/4"	8	14	131	800
DWM - 3	0,2 - 3				3/8"	10	19		
DWM - 8	0,3 - 8				1/2"	15	19		
DWM - 12	1 - 12				1/2"	15	19		
DWM - 18	2 - 18	27	30	71	1/2"	15	19	148	800
		32	30	71	3/4"	20	17	174	960
DWM - 35	3 - 35	34	40	76	3/4"	20	18	152	1450
DWM - 50	4 - 50	40			1"	25	19	156	1450

\* Other media on request

Operating data		DWM	
Operating pressure:		PN 200 bar (Brass)	PN 300 bar (Stainless Steel)
Pressure drop:		0,02 - 0,2 bar	
Maximum temperature:		100 °C (optional 160 °C)	
Accuracy:		± 5% of full scale	
Electrical data:		Normally open	Change over
IP 65 (plug connection DIN 43650)		max. 250V • 3A • 100VA	max. 250V • 1,5A • 50VA
IP 67 (1m sealed in cable)			
Atex II 2G EEx m II T6 (2m sealed in cable)		max. 250V • 2A • 60VA	max. 250V • 1A • 30VA
EEx m II T6 (2m sealed in cable)		max. 250V • 2A • 60VA	max. 250V • 1A • 30VA
EEx ia IIC T6 (2m sealed in cable)		max. 45V • 1A	max. 45V • 1A
Output signal:		The contact opens / changes, when the flow falls below the set point.	
Power supply:		Not required (potentialfree reed contact)	
Other plug types or cable lengths on request			
Material:		Brass	Stainless Steel
Wetted parts:		Brass nickel-plated	1.4571
Float: (wetted part)		Brass nickel-plated	1.4571
Gaskets: (wetted part)		Perbunan (optional Viton, EPDM)*	Viton (optional Perbunan, EPDM)*

\* Other gasket materials on request

DWM 2 0005 08-04 E M



# Flow Monitor

## DWM-L



### Operation

The flow monitors type DWM-L operate with the float measuring principle



### Application

The flow monitors type DWM-L are used for monitoring volumeflow of gaseous media.

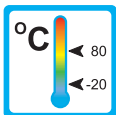

Areas of application:



– Coolingsystems and cooling-circuits



– Mechanical Engineering  
e.g. Weldingmachinery,  
Laserplants

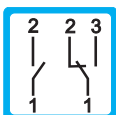

– Medicine technology

– Pharma industry

– Chemical industry

– Research and development



### Features

The DWM-L series proves itself through reliable function and easy handling. Further characteristics of this sturdy type are:

- high reliability
- high switch accuracy
- wide switch range
- infinitely variable switchpoint adjustment through user
- EX-version to ATEX available
- high pressure resistance
- Threaded connection  
Special threads on request

### Installation hints

The instrument must be installed vertically in the flow circuit. The flowdirection is from bottom to top.

The flow monitor must not be used as a supporting part in a pipeconstruction!

The medium must not contain any solid particles!  
We recommend the installation of strainers type SFD or SFM.

External magnetic fields influence the switch contact. Keep adequate distance to those magnetic fields (e.g. electromotors)!

The operating instruction for DWM-L must be observed under any circumstances!

DWM-L 1 0001 05-04 E M



# Measuring Range, Technical Data

## Connection diagram

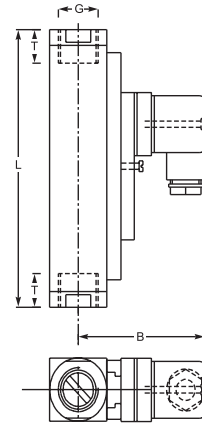
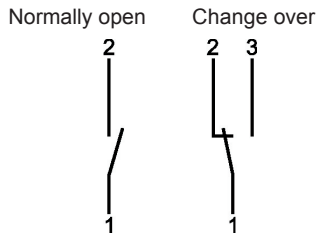

## Summary of types DWM-L

Typ	Switch range* Air [NI/min]	Overall dimensions mm							Weight approx. [g]
		SW	D	B	G	DN	T	L	
DWM - L1,5	1 - 28	27	30	71	1/4"	8	14	130	800
DWM - L3	4 - 60				3/8"	10	19		
DWM - L8	6 - 160				1/2"	15	19		
DWM - L12	20 - 240	27	30	71	1/2"	15	19	148	850
DWM - L18	40 - 360				3/4"	20	17		
DWM - L35	60 - 700	34	40	76	3/4"	20	18	152	1350
DWM - L50	80 - 1000	40			1"	25	19	156	1050
DWM - L100	200 - 1400	50	50	81	1"	25	20	200	2750

\* At 1 bar abs. and 20 °C, other media and/or operating conditions on request

Operating data	DWM-L	
Operating pressure:	PN 200 bar (Brass)	PN 300 bar (Stainless steel)
Pressure drop:	0,02 - 0,4 bar	
Maximum temperature:	80 °C	
Accuracy:	± 10% of full scale	
Electrical data:	Normally open	Change over
IP 65 (plug connection DIN 43650)	max. 250V • 3A • 100VA	max. 250V • 1,5A • 50VA
IP 67 (1m sealed in cable)		
Atex II 2G EEx m II T6 (2m sealed in cable)	max. 250V • 2A • 60VA	max. 250V • 1A • 30VA
EEx m II T6 (2m sealed in cable)	max. 250V • 2A • 60VA	max. 250V • 1A • 30VA
EEx ia IIC T6 (2m sealed in cable)	max. 45V • 1A	max. 45V • 1A
Output signal:	The contact opens / changes, when the flow falls below the set point.	
Power supply:	Not required (potentialfree reed contact)	
Other plug types or cable lengths on request		
Material:	Brass	Stainless steel
Wetted parts:	Brass nickel-plated	1.4571
Float: (wetted part)	Delrin	
Gaskets: (wetted part)	Perbunan (optional Viton, EPDM)*	Viton (optional Perbunan, EPDM)*

\* Other gasket materials on request

DWM-L 2 0005 05-04 E M



# Flow Monitor Flow Indicator

## DUM/A

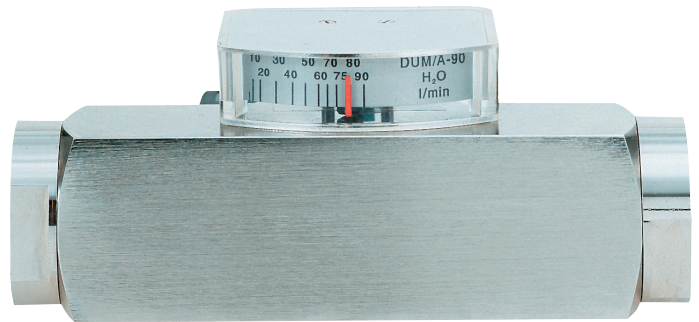

### Operation

The flow monitors and indicators type DUM/A operate with the float measuring principle



### Application

The flow monitors and indicators type DUM/A are used for measuring and monitoring volumeflow of liquid media.

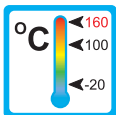

Areas of application:



– Coolingsystems and cooling-circuits



– Mechanical Engineering  
e.g. Weldingmachinery  
and Laserplants

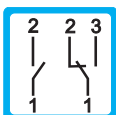

– Medicine technology

– Pharma industry

– Chemical industry



– Research and development



### Features

The DUM/A series proves itself through reliable function and easy handling. Further characteristics of this sturdy type are:

- universal orientation
- high reliability
- high switch accuracy
- wide measuring range
- infinitely variable switchpoint adjustment through user
- EX-version to ATEX available
- high pressure resistance
- Threaded connection  
Special threads on request

### Installation hints

The installation of the instrument can be done in any way in the system. The flow direction must be observed.

The instrument must not be used as a supporting part in a pipeconstruction!

The medium must not contain any solid particles!  
We recommend the installation of strainers type SFD or SFM.

External magnetic fields influence the switch contact. Keep adequate distance to those magnetic fields (e.g. electromotors)!

The operating instruction for DUM/A must be observed under any circumstances!

DUM/A 1 0002 10-04 E M



# Measuring Ranges, Technical Data

## Connection diagram

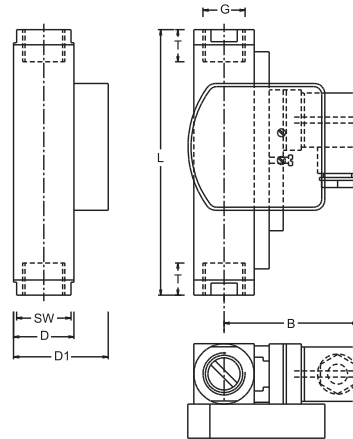
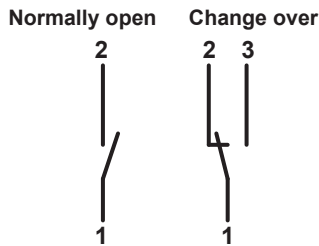

## Summary of types DUM/A

Type	Switch range* H <sub>2</sub> O [l/min]	Overall dimensions mm								Weight approx. [g]
		SW	D	D1	B	G	DN	T	L	
DUM/A - 4	0,2 - 4	27	30	47	71	1/4"	8	14	130	900
DUM/A - 5	0,6 - 5					3/8"				
DUM/A - 8	0,5 - 8					1/2"				
DUM/A - 14	1 - 14					15				
DUM/A - 28	1 - 28	27	30	47	71	1/2"	15	14	148	950
DUM/A - 40	2 - 40					3/4"				
DUM/A - 55	4 - 55					20				
DUM/A - 70	1 - 70					16				
DUM/A - 90	8 - 90	34	40	57	76	3/4"	20	18	152	1450
DUM/A - 110	5 - 110					1"				
DUM/A - 150	10 - 150	40	40	57	76	1 1/4"	32	21	200	2800
DUM/A - 220	35 - 220	50	50	67	81	1 1/4"	32	21	200	3050
DUM/A - 250	35 - 250	60	60	77	82	1 1/2"	40	24	200	3850

\* Other media on request

Operating data		DUM/A	
Operating pressure:		PN 200 bar (Brass)	PN 300 bar (Stainless Steel)
Pressure drop:		0,02 - 0,8 bar	
Maximum temperature:		100 °C (optional 160 °C)	
Accuracy:		± 5% of full scale	
Electrical data		Normally open	Change over
IP 65 (plug connection DIN 43650)		max. 250V • 3A • 100VA	max. 250V • 1,5A • 50VA
IP 67 (1 m sealed in cable)			
Atex II 2G EEx m II T6 (2 m sealed in cable)		max. 250V • 2A • 60VA	max. 250V • 1A • 30VA
EEx m II T6 (2 m sealed in cable)		max. 250V • 2A • 60VA	max. 250V • 1A • 30VA
EEx ia IIC T6 (2 m sealed in cable)		max. 45V • 1A	max. 45V • 1A
Output signal:		The contact opens / changes, when the flow falls below the set point.	
Power supply:		Not required (potentialfree reed contact)	
Other plug types or cable lengths on request			
Material		Brass	Stainless Steel
Wetted parts:		Brass nickel-plated	1.4571
Spring:	(wetted part)	1.4571	1.4571
Gaskets:	(wetted part)	Perbunan (optional Viton, EPDM)*	Viton (optional Perbunan, EPDM)*
Display:		Makrolon / Brass nickel plated	

\* Other gasket materials on request



# Flow Monitor

## DUM

### Operation

The flow monitors type DUM operate with the float measuring principle

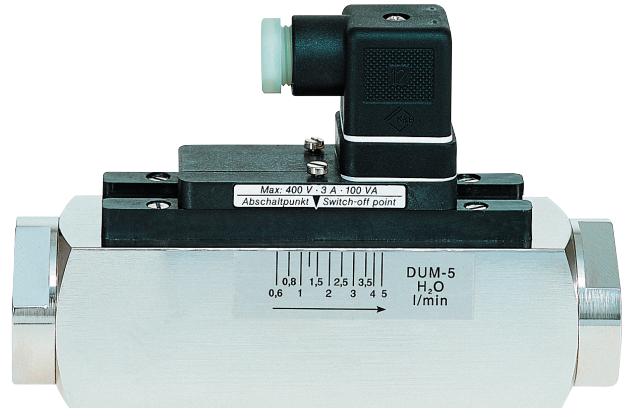

### Application

The flow monitors type DUM are used for monitoring volumeflow of liquid media.

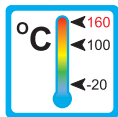

Areas of application:

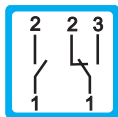

- Coolingsystems and cooling-circuits
- Mechanical Engineering e.g. Weldingmachinery and Laserplants
- Medicine technology
- Pharma industry
- Chemical industry
- Research and development

### Features

The DUM series proves itself through reliable function and easy handling. Further characteristics of this sturdy type are:

- universal orientation
- high reliability
- high switch accuracy
- wide switch range
- infinitely variable switchpoint adjustment through user
- EX-version to ATEX available
- high pressure resistance
- Threaded connection  
Special threads on request

### Installation hints

The installation of the flow monitor can be done in any way in the system. The flow direction must be observed.

The flow monitor must not be used as a supporting part in a pipeconstruction!

The medium must not contain any solid particles! We recommend the installation of strainers type SFD or SFM.

External magnetic fields influence the switch contact. Keep adequate distance to those magnetic fields (e.g. electromotors)!

The operating instruction for DUM must be observed under any circumstances!

DUM 1 0002 10-04 E M



# Measuring Ranges, Technical Data

## Connection diagram

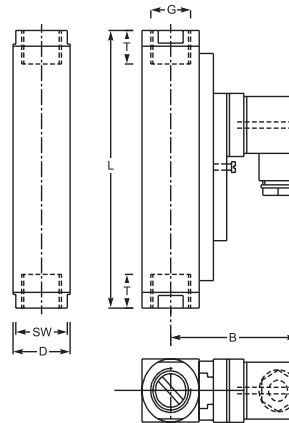
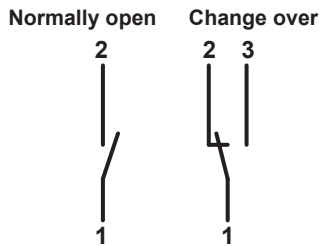

## Summary of types DUM

Type	Switch range* H <sub>2</sub> O [l/min]	Overall dimensions mm							Weight approx. [g]				
		SW	D	B	G	DN	T	L					
DUM - 4	0,2 - 4	27	30	71	1/4"	8	14	130	850				
DUM - 5	0,6 - 5				3/8"								
DUM - 8	0,5 - 8				1/2"								
DUM - 14	1 - 14				15								
DUM - 28	1 - 28				15								
DUM - 40	2 - 40	27	30	71	1/2"	15	14	148	900				
DUM - 55	4 - 55				3/4"					20	16		
DUM - 70	1 - 70	34	40	76	3/4"	20	18	152	1400				
DUM - 90	8 - 90				1"					25	19	156	1100
DUM - 110	5 - 110				40					40	76	1 1/4"	32
DUM - 150	10 - 150	50	50	81	1 1/4"	32	21	200	3000				
DUM - 220	35 - 220	60	60	82	1 1/2"	40	24	200	3800				
DUM - 250	35 - 250				1 1/2"					40	24	200	3800

\* Other media on request

Operating data	DUM	
Operating pressure:	PN 200 bar (Brass)	PN 300 bar (Stainless Steel)
Pressure drop:	0,02 - 0,8 bar	
Maximum temperature:	100 °C (optional 160 °C)	
Accuracy:	± 5% of full scale	
Electrical data	Normally open	Change over
IP 65 (plug connection DIN 43650)	max. 250V • 3A • 100VA	max. 250V • 1,5A • 50VA
IP 67 (1 m sealed in cable)		
Atex II 2G EEx m II T6 (2 m sealed in cable)	max. 250V • 2A • 60VA	max. 250V • 1A • 30VA
EEx m II T6 (2 m sealed in cable)	max. 250V • 2A • 60VA	max. 250V • 1A • 30VA
EEx ia IIC T6 (2 m sealed in cable)	max. 45V • 1A	max. 45V • 1A
Output signal:	The contact opens / changes, when the flow falls below the set point.	
Power supply:	Not required (potentialfree reed contact)	
Other plug types or cable lengths on request		
Material	Brass	Stainless Steel
Wetted parts:	Brass nickel-plated	1.4571
Spring: (wetted part)	1.4571	1.4571
Gaskets: (wetted part)	Perbunan (optional Viton, EPDM)*	Viton (optional Perbunan, EPDM)*

\* Other gasket materials on request

DUM 2 0007 10-04 E.M





# Flow Monitor

## RVM/U

### Operation

The flow monitors type RVM/U operate with the float measuring principle



### Application

The flow monitors type RVM/U are used for measuring volumeflow of liquid media.

Areas of application:

- Coolingsystems and cooling-circuits
- Mechanical Engineering e.g. Weldingmachinery, Laserplants
- Medicine technology
- Pharma industry
- Chemical industry
- Research and development

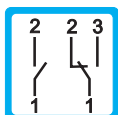
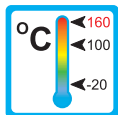

### Features

The RVM/U series proves itself through reliable function and easy handling. Further characteristics of this sturdy type are:

- univseral mounting
- high switch accuracy
- infinitely variable switchpoint adjustment through user
- EX-version to ATEX for RVM/U-1... and for RVM/U-2... available
- high pressure resistance
- Threaded connection  
Special threads on request

### Installation hints

The installation of the flow monitor can be done in any way in the system. The flow direction must be observed.

The flow monitor must not be used as a supporting part in a pipeconstruction!

The medium must not contain any solid particles! We recommend the installation of strainers type SFD or SFM.

External magnetic fields influence the switch contact. Keep adequate distance to those magnetic fields (e.g. electromotors)!

The operating instruction for RVM/U must be observed under any circumstances!

RVM/U 1 0001 08-04 E M





# Measuring Ranges, Technical Data

## Connection diagram:

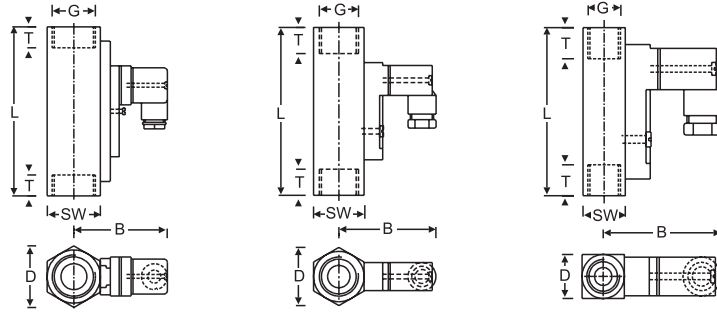
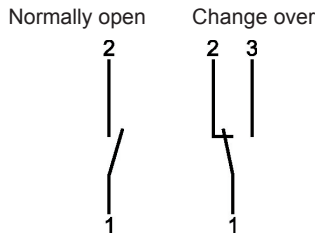

## Summary of types RVM/U

Type	Range* l/min H <sub>2</sub> O	Overall dimensions mm							Weight approx. [g]
		SW	D	B	G	DN	T	L	
RVM/U-4/01	0,005 - 0,06	17	17	47	1/4"	8	10	65	140
RVM/U-4/02	0,04 - 0,13								
RVM/U-4/06	0,1 - 0,6								
RVM/U-4/1	0,2 - 1,2								
RVM/U-4/2	0,4 - 2,0								
RVM/U-4/3	0,5 - 3,0								
RVM/U-4/5	1,0 - 5,0	27	31	52	1/2"	15	14	90	350
RVM/U-2/02	0,02 - 0,2								
RVM/U-2/06	0,2 - 0,6								
RVM/U-2/1	0,4 - 1,8								
RVM/U-2/3	0,8 - 3,2								
RVM/U-2/7	2 - 7								
RVM/U-2/13	3 - 13	41	47	76	3/4"	20	21	152	1200
RVM/U-2/20	4 - 20								
RVM/U-2/30	8 - 30								
RVM/U-1/30	11 - 30								
RVM/U-1/45	15 - 45								
RVM/U-1/60	20 - 60								
RVM/U-1/90	30 - 90	41	47	76	1"	25	17	130	1050
RVM/U-1/150	60 - 150								

\* The stated values are switch-off points, other switch ranges on request.

Operating data	RVM/U-1	RVM/U-2	RVM/U-4
Operating pressure: Brass	PN 250 bar	PN 300 bar	PN 300 bar
Operating pressure: Stainless Steel	PN 300 bar	PN 350 bar	PN 350 bar
Pressure drop:	0,02 - 0,4 bar	0,02 - 0,3 bar	0,02 - 0,2 bar
Maximum temperature:	100 °C (optional 160 °C)		
Accuracy:	10% of full scale		
Electrical data			
Normally open:	max. 250V • 3A • 100VA	max. 230V • 3A • 60VA	max. 200V • 1A • 20VA
Change over:	max. 250V • 1,5A • 50VA	max. 250V • 1,5A • 50VA	max. 200V • 1A • 20VA
Atex II 2 G EEx m II T6	(only for RVM/U-1 / RVM/U-2)	Change over: 250V • 1A • 30VA, IP67 / Normally open: 250V • 2A • 60 VA, IP67	
Atex II 2 D IP67 T80 °C	(only for RVM/U-1 / RVM/U-2)	Change over: 250V • 1A • 30VA, IP67 / Normally open: 250V • 2A • 60 VA, IP67	
Protection type:	IP65 (plug connection DIN 43650 Form A or C) IP67 (1m sealed in cable, with EEx-version 2 m)		
Output signal:	The contact opens / changes, when the flow falls below the set point.		
Power supply:	Not required (potentialfree reed contacts)		
other plug types or cable lengths on request			
Material	Brass	Stainless Steel	
Wetted parts:	Brass	1.4571	
Spring:	1.4571	1.4571	
Magnets:	Hardferrit	Hardferrit	
Housing:	Brass nickel-plated	1.4571	

RVM/U 2 0006 12-04 E M



# Flow Monitor

## RVM/U-L

### Operation

The flow monitors type RVM/U-L operate with the float measuring principle



### Application

The flow monitor type RVM/U-L are used for measuring volumeflow of gaseous media.

Areas of application:

- Coolingsystems and cooling-circuits
- Mechanical Engineering eg. Weldingmachinery, Laserplants
- Medicine technology
- Pharma industry
- Chemical Industry
- Research and development

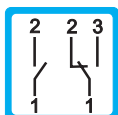
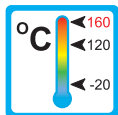

### Features

The RVM/U-L series proves itself through reliable function and easy handling. Further characteristics of this sturdy type are:

- universal mounting
- high reliability
- high switch accuracy
- infinitely variable switchpoint adjustment through user
- EX-version to ATEX for RVM/U-L1... and for RVM/U-L2... available
- high pressure resistance
- Threaded connection  
Special threads on request

### Installation hints

The installation of the flow monitor can be done in any way in the system. The flow direction must be observed.

The flow monitor must not be used as a supporting part in a pipeconstruction!

The medium must not contain any solid particles! We recommend the installation of strainer type SFD or SFM.

External magnetic fields influence the switch contact. Keep adequate distance to those magnetic fields (e.g. electromotors)!

The operating instruction for RVM/U-L must be observed under any circumstances!

RVM/U-L 1 0001 06-04 E M



# Measuring Ranges, Technical Data

## Connection diagram:

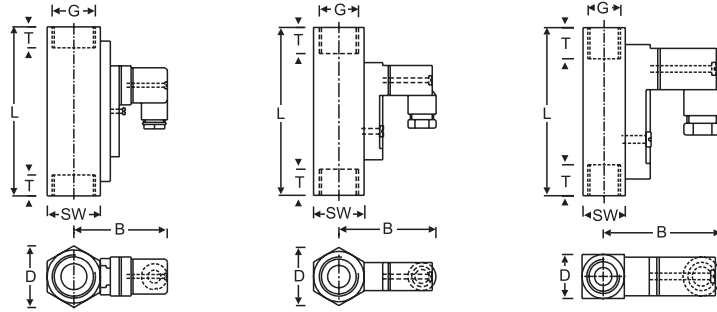
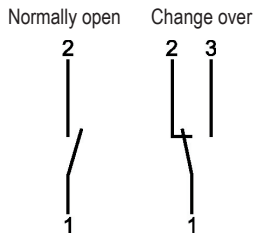

## Summary of types RVM/U-L

Type	Range* NI/min Air	Overall dimensions mm							Weight approx. [g]
		SW	D	B	G	DN	T	L	
RVM/U-L40002	0,6 - 2,2	17	17	47	1/4"	8	10	65	140
RVM/U-L40006	1,7 - 6								
RVM/U-L40008	2,5 - 8								
RVM/U-L40012	3 - 12								
RVM/U-4/06L	3 - 22								
RVM/U-L40024	7 - 24								
RVM/U-L40034	12 - 34								
RVM/U-4/2L	16 - 56								
RVM/U-4/3L	20 - 80	27	31	52	1/2"	15	14	90	350
RVM/U-L20010	2,5 - 10								
RVM/U-L20020	5,5 - 20								
RVM/U-L20030	8 - 30								
RVM/U-L20035	10 - 35								
RVM/U-2/3L	24 - 90								
RVM/U-L20220	55 - 220								
RVM/U-L20240	65 - 240								
RVM/U-L20300	80 - 300	41	47	76	3/4"	20	21	152	1200
RVM/U-L10180	60 - 180								
RVM/U-L10300	100 - 300								
RVM/U-L10650	200 - 650				1"	25	17	130	1050

\* At 1 bar abs. and 20 °C, other ranges on request

Operating data	RVM/U-L1	RVM/U-L2	RVM/U-L4
Operating pressure: Brass	PN 250 bar	PN 300 bar	PN 300 bar
Operating pressure: Stainless steel	PN 300 bar	PN 350 bar	PN 350 bar
Pressure drop:	0,02 - 0,4 bar	0,02 - 0,3 bar	0,02 - 0,2 bar
Maximum temperature:	120 °C (optional 160 °C)		
Accuracy:	10% of full scale		
<b>Electrical data:</b>			
Normally open:	max. 250V • 3A • 100VA	max. 230V • 3A • 60VA	max. 200V • 1A • 20VA
Change over:	max. 250V • 1,5A • 50VA	max. 250V • 1,5A • 50VA	max. 200V • 1A • 20VA
Atex II 2G EEx m II T6	(only for RVM/U-L1 / RVM/U-L2) Change over: 250V • 1A • 30VA, IP67 / Normally open: 250V • 2A • 60 VA, IP67		
EEx m II T6	(only for RVM/U-L1 / RVM/U-L2) Change over: 250V • 1A • 30VA, IP67 / Normally open: 250V • 2A • 60 VA, IP67		
EEx ia IIC T6	(only for RVM/U-L1 / RVM/U-L2) Change over / Normally open: 45V • 1A, IP67		
Protection type:	IP65 (plug connection DIN 43650 Form A or C) IP67 (1m sealed in cable, with EEx-version 2m)		
Output signal:	The contact opens / changes, when the flow falls below the set point.		
Power supply:	Not required (potential free reed contacts)		
Other plug-types or cable length on request			
<b>Material:</b>	<b>Brass</b>	<b>Stainless Steel</b>	
Wetted parts:	Brass	1.4571	
Spring:	(wetted part) 1.4571	1.4571	
Magnets:	(wetted part) Hardferrit	Hardferrit	
Housing:	(wetted part) Brass nickel-plated	1.4571	

RVM/U-L 2 0004 06-04 E M



# Flow Monitor

## RVM/UM

### Operation

The flow monitors type RVM/UM operate with the float measuring principle



### Application

The flow monitors type RVM/UM are used for monitoring volumeflow of liquid media.

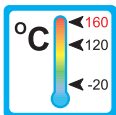

Areas of application:



– Coolingsystems and cooling-circuits



– Mechanical Engineering  
e.g. Weldingmachinery,  
Laserplants

– Research and development

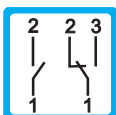

### Features

The RVM/UM series proves itself through reliable function and easy handling. Further characteristics of this sturdy type are:

- universal mounting
- high switch accuracy
- high flowrate at low switch-point
- EX-version to ATEX available
- high pressure resistance
- Threaded connection  
Special threads on request

### Installation hints

The installation of the flow monitor can be done in any way in the system. The flow direction must be observed.

The flow monitor must not be used as a supporting part in a pipeconstruction!

The medium must not contain any solid particles!  
We recommend the installation of strainers type SFD or SFM.

External magnetic fields influence the switch contact. Keep adequate distance to those magnetic fields (e.g. electromotors)!

The operating instruction for RVM/UM must be observed under any circumstances!



# Measuring Ranges, Technical Data

## Connection diagram

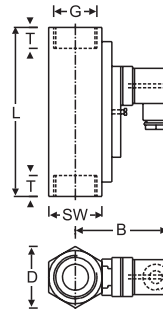
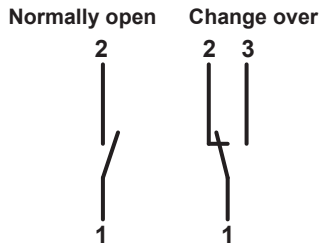

RVM/UM

## Dimensions and weights

Type	Overall dimensions mm							Weight approx. [g]
	SW	D	B	G	DN	T	L	
RVM/UM	41	47	72	1"	25	20	130	1000

## Switch points and pressure drop

Type	RVM/UM
Lowest switch point (at decreasing flow)*:	0,1 l/min
Highest switch point (at decreasing flow)*:	30 l/min
* The switch point is factory adjusted.	
Please specify switch point when ordering!	
The recommended maximum flow is 120 l/min	

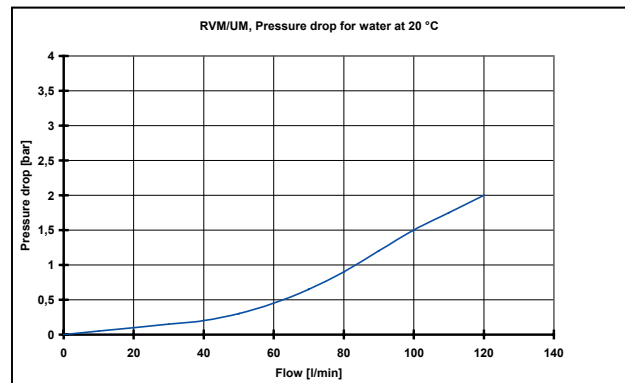

Operating data	RVM/UM	
Operating pressure:	PN 250 bar (Brass)	PN 300 bar (Stainless Steel)
Pressure drop:	see diagram above	
Maximum temperature:	120°C (optional 160°C)	
Accuracy:	switch point > 3 l/min: ±5% of switch value	switch point ≤ 3 l/min: ±0,1 l/min
Electrical data	Normally open	Change over
IP 65 (plug connection DIN 43650 Form A)	max. 250V • 3A • 100VA	max. 250V • 1,5A • 50VA
IP 67 (1m sealed in cable)		
Atex II 2G EEx m II T6 (2m sealed in cable)	max. 250V • 2A • 60VA	max. 250V • 1A • 30VA
EEx m II T6 (2m sealed in cable)	max. 250V • 2A • 60VA	max. 250V • 1A • 30VA
EEx ia IIC T6 (2m sealed in cable)	max. 45V • 1A	max. 45V • 1A
Output signal:	The contact opens / changes, when the flow falls below the set point.	
Power supply:	Not required (potentialfree reed contacts)	
Other plug types or cable lengths on request		
Material	Brass	Stainless Steel
Wetted parts:	Brass	1.4571
Spring: (wetted part)	1.4571	
Magnets: (wetted part)	Hardferrit	
Housing: (wetted part)	Brass nickel-plated	1.4571

RVM/UM 2 0002 12-04 E M



# Flow Monitor

## RMU

### Operation

The flow monitors type RMU operate with the float measuring principle



### Application

The flow monitors type RMU are used for monitoring volumeflow of liquid media.

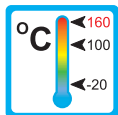

Areas of application:



- Power cleaner
- Coolingsystems and cooling-circuits
- Mechanical Engineering e.g. Weldingmachinery, Laserplants
- Research and development

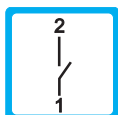

### Features

The RMU series proves itself through reliable function and easy handling. Further characteristics of this sturdy type are:

- universal mounting
- low sensivity to dirt
- infinitely variable switchpoint adjustment through user
- high pressure resistance
- Threaded connection  
Special threads on request

### Installation hints

The installation of the flow monitor can be done in any way in the system. The flow direction must be observed.

The flow monitor must not be used as a supporting part in a pipeconstruction!

The medium must not contain any solid particles! We recommend the installation of strainers type SFD or SFM.

External magnetic fields influence the switch contact. Keep adequate distance to those magnetic fields (e.g. electromotors)!

The operating instruction for RMU must be observed under any circumstances!

RMU 1 0001 08-04 E M



# Measuring Ranges, Technical Data

## Connection diagram:

Normally open

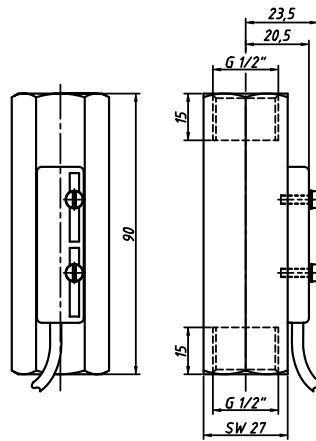

RMU-A

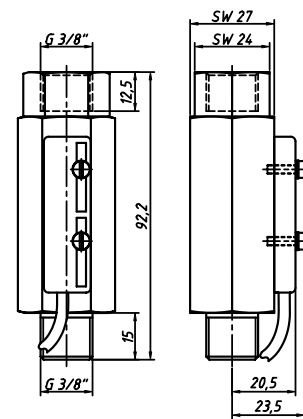

RMU-B

## Summary of types RMU

Type	Switch range (H <sub>2</sub> O) [l/min]	Pressure drop [mbar]	Thread (inlet)	Thread (outlet)	Weight (approx.) [g]
RMU-A11	2,5 — 11,0	25 — 175	G 1/2" Female	G 1/2" Female	320
RMU-A15	5,0 — 15,5	85 — 250	G 1/2" Female	G 1/2" Female	320
RMU-B02	0,4 — 2,1	25 — 175	G 3/8" Male	G 3/8" Female	320
RMU-B12	3,0 — 12,5	75 — 275	G 3/8" Male	G 3/8" Female	320
RMU-B18	8,5 — 18,5	125 — 300	G 3/8" Male	G 3/8" Female	320

## Technical Data

Operating Data	RMU-A	RMU-B
Operating pressure:	PN 250 bar	PN 250 bar
Maximum temperature:	100 °C (optional 160 °C)	100 °C (optional 160 °C)
Accuracy:	10 % of full scale	10 % of full scale

## Electrical Data

Normally open:	max. 230V • 3A • 60VA	max. 230V • 3A • 60VA
Protection type:	IP67 (1m sealed in cable)	IP67 (1m sealed in cable)
Output signal:	The contact opens, when the flow falls below the set point	
Power supply:	Not required (potentialfree reed contact)	

Other cable lengths on request

## Material

Body	(wetted part)	Brass	Brass
Float	(wetted part)	Brass	Brass
Spring	(wetted part)	1.4571	1.4571
Magnets	(wetted part)	Hardferrit	Hardferrit
Gasket	(wetted part)	—	NBR*

\*Other gasket materials on request

RMU 2 0001 08-04 E M





## SC-250

### Operation

The instruments, type SC-250, are variable area flowmeter

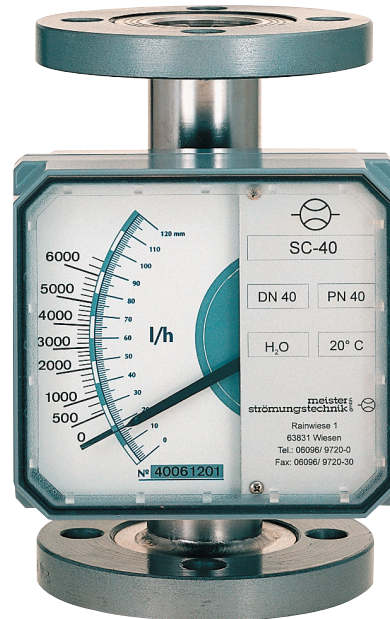

### Application

The flowmeters, type SC-250, are employed to monitor volumeflow of liquids and gases. The instruments are used in many different applications:

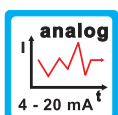
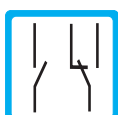
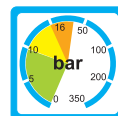
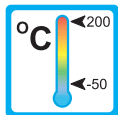

### Features

The SC-250 prove themselves through reliability and simply handling. Further properties of this sturdy series are:

- high reliability
- product designated scale at no charge
- high chemical compatibility with Teflon-lining (optional)
- flange connection  
special process connection on request

### Installation hints

The instrument must be installed vertical. The flowdirection is from bottom to top.

The flowmeter must not be used as a supporting part in a pipeconstruction!

The medium must not contain any solid particles!

Keep adequate distance to magnetic fields (e.g. electro-motors)!





## Technical Data

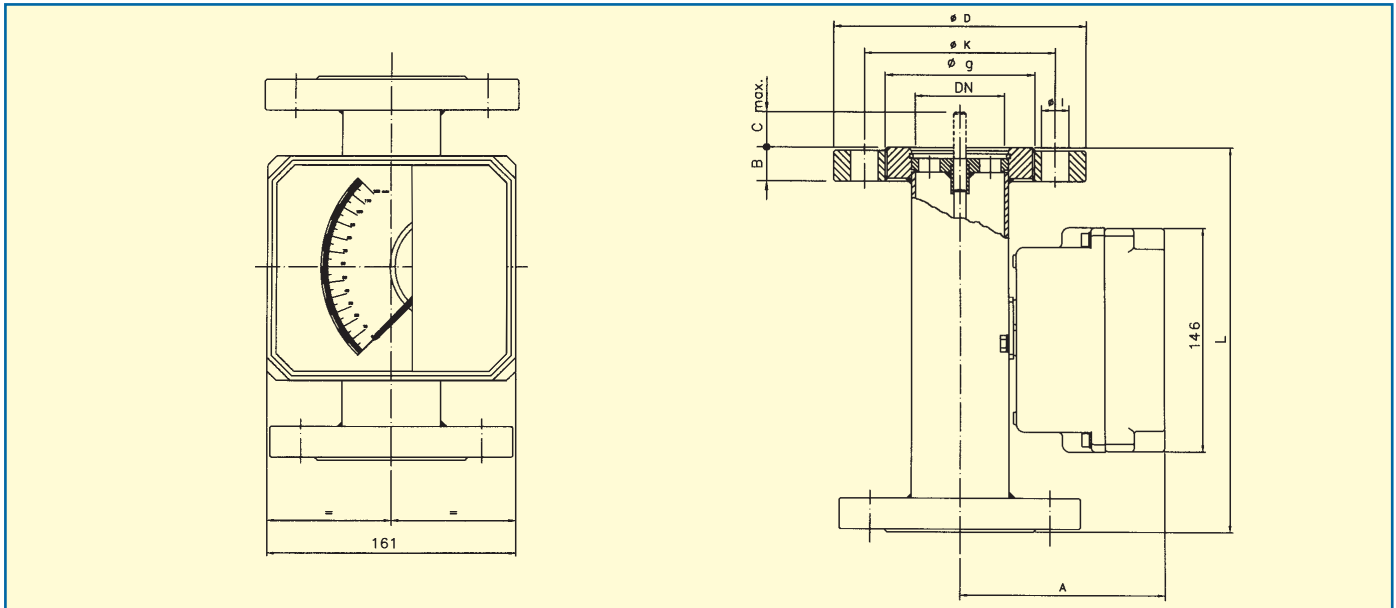

### Dimensions and weights of the version to DIN 2501

DN	D [mm]	K [mm]	g [mm]	l	B [mm]	PN	A [mm]	C [mm]	L [mm]	weight [kg]
15	95	65	45	14x4	14	40	133	45	250	3,5
25	115	85	68	14x4	16	40	146	45	250	4,5
40	150	110	88	18x4	16	40	154	45	250	7,3
50	165	125	102	18x4	18	40	167	45	250	8,3
65	185	145	122	18x4	18	16	176	45	250	10
80	200	160	138	18x8	20	16	192	45	250	12
100	220	180	158	18x8	20	16	211	–	250	15
125	250	210	188	18x8	22	16	236	–	250	20
150	285	240	212	23x8	22	16	262	–	300	32

### Technical Data

<b>Measuring ranges:</b>		<b>Accuracy:</b>	
Water	refer to table on page 4	standard	± 2,5 % of full scale
Air	refer to table on page 4	optional	± 1,6 % of full scale
<b>Medium temperature:</b>		<b>Ambient temperature:</b>	
Stainless Steel	-50 °C to +200 °C	Stainless Steel	-20 °C to +80 °C
PVC (fully)	0 °C to +50 °C	PVC	0 °C to +45 °C
PTFE (lined)	-20 °C to +150 °C	PTFE	-20 °C to +80 °C
<b>Pressure (1.4404):</b>	refer to table above	<b>Viscosity max.:</b>	10 cP
<b>Operating pressure PVC- und PP-version:</b>			
DN-15 bis DN-50	PN16	DN-65 bis DN-150	PN10
<b>Operating pressure PTFE-version:</b>			
DN-15 bis DN-40	PN40	DN-50 bis DN-125	PN16
DN-150	PN10		
<b>Connection (standard):</b> flanges to DIN 2501			
on request ANSI-, ASA-, BTS-flanges, thread connection, sanitary connection to DIN 11851			
<b>Scale:</b> medium customised, 120 mm, various units e.g.: l/h, m³/h, kg/h			
<b>Special versions (on request):</b>			
High temperature version	-180 °C to +400 °C (only 1.4404)		
PP-version (fully)	0 °C to +80 °C		
<b>Ingress protection:</b>	IP 65	<b>Cable entry:</b>	PG9-cable gland
<b>Heating jacket:</b>	on request		

SC-250 2 0001 07-04 E M



# Materials and float types

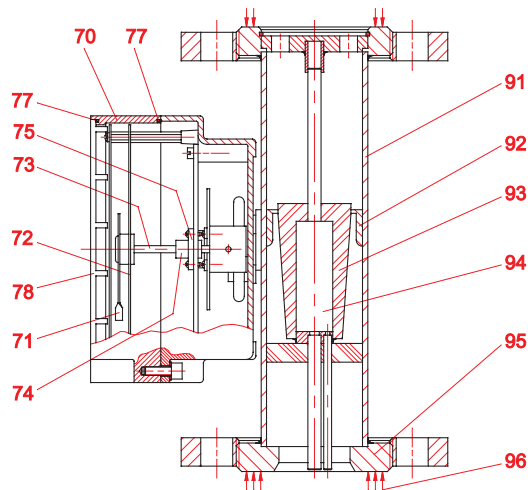

## Materials measuring tube

Nr.	Description	Materials		
		Stainless Steel	PVC / PP	PTFE
91	Measuring tube	1.4404	PVC / PP	1.4404+PTFE
92	Orifice	1.4404	PVC / PP	PTFE
93	Float	1.4404	PVC / PP	PTFE
94	Magnet	Alnico		
95	Ring flange	Steel*	PVC / PP	1.4401
96	Flange - sealing surface	1.4404	PVC / PP	1.4404+PTFE

\* Stainless Steel on request

## Materials indicator

Nr.	Description	Materials
70	Housing	Aluminum
71	Pointer	Aluminum
72	Scale disc	Aluminum
73	Axle	Stainless Steel 1.4401
74	Ball bearing	Stainless Steel 1.4401
75	Magnetic brake	Neodymium
77	Gasket	NBR
78		Polycarbonate / glass

## Float types

**Type FC  
DN-15 to DN-80**

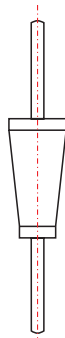

**Type FC  
DN-100 to DN-150**

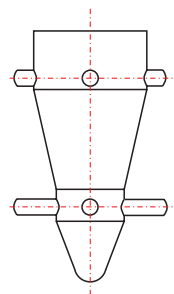

SC-250 3 0001 07-04 E M



## Measuring ranges

### Standard ranges for Stainless Steel float and PVC-float

DN	Float №	Float in 1.4404			Float in PVC *3	
		H <sub>2</sub> O [l/h]	Air *1*2 [Nm <sup>3</sup> /h]	Pressure drop [mm H <sub>2</sub> O]	Air *1 [Nm <sup>3</sup> /h]	Pressure drop [mm H <sub>2</sub> O]
15	15025	2,5 – 25	0,07 – 0,7	400	–	–
	15040	4 – 40	0,12 – 1,2	400	0,2 – 2	240
	15060	6 – 60	0,18 – 1,8	400	0,4 – 4	240
	15100	10 – 100	0,3 – 3	400	0,6 – 6	240
	15160	16 – 160	0,5 – 5	500	1 – 10	240
	15250	25 – 250	0,7 – 7,5	500	1,6 – 16	240
	15400	40 – 400	1,2 – 12	500	2 – 20	240
	15600	60 – 600	1,8 – 18	500	–	–
25	25100	100 – 1000	3 – 30	600	0,6 – 6	180
	25160	160 – 1600	5 – 50	700	1 – 10	180
	25250	250 – 2500	7 – 75	900	1,6 – 16	180
	25400	400 – 4000	12 – 120	1100	2,5 – 25	180
	25101	–	–	–	4 – 40	180
	25161	–	–	–	6 – 60	180
	25251	–	–	–	9 – 96	180
40	40400	400 – 4000	12 – 120	450	5 – 50	260
	40600	500 – 6300	15 – 180	550	8 – 80	260
	40800	800 – 8000	24 – 240	900	14 – 140	260
50	50800	800 – 8000	24 – 240	700	9 – 90	220
	50100	1000 – 10000	30 – 300	900	15 – 150	220
	50150	1500 – 15000	45 – 450	1000	20 – 200	220
	50101	–	–	–	35 – 350	220
65	65150	1500 – 15000	45 – 450	700	25 – 250	220
	65200	2000 – 20000	60 – 600	1000	40 – 400	220
80	80020	2000 – 20000	60 – 600	800	40 – 400	230
	80025	2500 – 25000	75 – 750	1000	60 – 600	230
	80030	3000 – 30000	90 – 900	1200	–	–
100	81040	4000 – 40000	120 – 1200	1000	60 – 600	240
	81050	5000 – 50000	150 – 1500	1200	100 – 1000	240
	81060	6000 – 60000	180 – 1800	1500	–	–
125	82080	8000 – 80000	240 – 2400	1200	150 – 1500	280
	82100	10000 – 100000	300 – 3000	1500	200 – 2000	280
	82120	12000 – 120000	360 – 3600	1800	–	–
150	83150	15000 – 150000	450 – 4500	2200	250 – 2600	320
	83180	18000 – 180000	500 – 5400	2200	300 – 3200	320

\*1 At 1,013 bar abs., 20 °C

\*2 Damper is recommended (DN-15 to DN-80)

\*3 Up to 40 °C, for higher temperatures a PTFE-float must be used

Measuring ranges for other media and operating conditions on request!



# Electronic measuring transducers and limitswitches

## Adjustable micro-limitswitch type SC-AMM

Bistable microswitch installed in the indicator housing of the flowmeter

- SC-AMM1: 1 adjustable limitswitch
- SC-AMM2: 2 adjustable limitswitches
- Switch values: 3 (1) A / 250 V (VDE/CEE)
- Hysteresis:  $\pm 10\%$  of endvalue
- Ambient temperature:  $-25\text{ }^{\circ}\text{C}$  to  $+80\text{ }^{\circ}\text{C}$
- Mechanical lifetime:  $10^7$  switch operations
- Supply: 220 V AC, load: 6 A      24 V DC, load: 0,5 A

(gold plated on request)

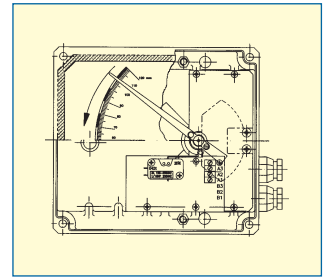

## Adjustable inductive limitswitch type SC-AMD

Inductive proximityswitch, 3,5 mm, according to standard NAMUR DIN 19234, installed in the indicator housing of the flowmeter

- SC-AMD1...2: 1...2 adjustable limitswitches
- Power supply: 8 V DC (via amplifier)
- Temperature:  $-25\text{ }^{\circ}\text{C}$  to  $+70\text{ }^{\circ}\text{C}$

### Amplifier (on request)

Model NAMUR (DIN 19234) for 1 or 2 adjustable inductive contacts

- Power supply: 24...230 V AC, 50 - 60 Hz      24...250 V DC
- Input: intrinsic safe circuit EEx ia IIC
- Output: 1 or 2 relays
- Load: 2...5 A / 40 V DC
- Temperature:  $-25\text{ }^{\circ}\text{C}$  to  $+70\text{ }^{\circ}\text{C}$

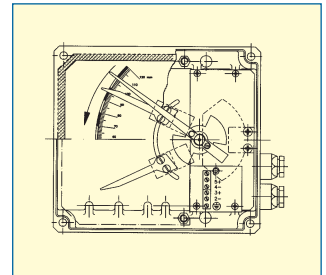

## Electronic measuring transducer HALLTEC III

The HALLTEC III is a transducer in 2 wire or 4 wire technique with a hall effect sensor. The hall sensor is based on the non contact sensing through the indicator mechanism.

### Model:

- |                              |                              |
|------------------------------|------------------------------|
| 2 wire:                      | 4 wire:                      |
| TH32 transducer              | TH34 transducer              |
| TH32T transducer + totalizer | TH34T transducer + totalizer |

- Power supply: 10...50 V DC (2 wire), 24...240 V AC (4 wire)
- max. current / load consumption: max. 20 mA (2 wire), < 2 VA (4 wire)
- Analog output: 4 - 20 mA
- Accuracy: 0,6 % referenced to the magnet position
- Load max.: 2 k $\Omega$
- Pulse output: MOSFET potentialfree N-channel
- I max.: 200 mA
- max. frequency: 2 Hz
- Pulse length: approx. 250 ms
- Totalizer: 9 digits, 4,5 mm peak with reset via potentialfree contact
- Ambient temperature:  $-25\text{ }^{\circ}\text{C}$  to  $+70\text{ }^{\circ}\text{C}$

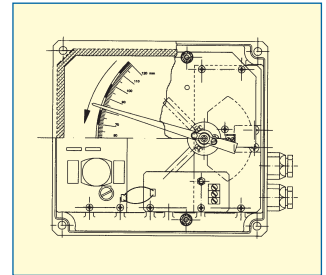

## Electronic measuring transducer HALLTEC III (EEx ia IIC T4 ATEX)

### Model:

- 2 wire:
- TH32Ex transducer
- TH32TEEx transducer + totalizer

- max. current: 20 mA
- Analog output: 4 - 20 mA
- Accuracy: 0,6 % referenced to the magnet position
- Load max.: 700  $\Omega$  at 24 V DC power supply
- Totalizer: 9 digits, 4,5 mm peak with reset via potentialfree contact
- Ambient temperature:  $-5\text{ }^{\circ}\text{C}$  to  $+40\text{ }^{\circ}\text{C}$

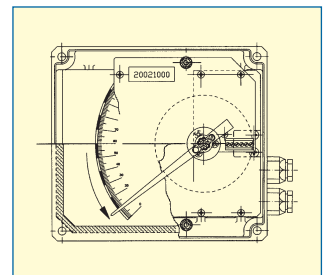

SC-250 5 0001 08-04 E M



## Flow monitors and flow indicators for oil viscosity compensated

Types: **DKG**, **DKM/A**, **DKM**, **DKME**, **DKME/A**

### DKG



**Flow monitor and indicator for oil**

- viscosity compensated
- special liquids
- installation in any orientation

### DKM/A



**Flow monitor and indicator for oil**

- viscosity compensated
- special liquids
- high operating pressure
- installation in any orientation

### DKM



**Flow monitor for oil**

- viscosity compensated
- special liquids
- high operating pressure
- installation in any orientation

### DKME



**Flow monitor and indicator for oil**

- large switch range
- viscosity compensated
- special liquids
- installation in any orientation

### DKME/A



**Flow monitor and indicator for oil**

- large measuring range
- viscosity compensated
- special liquids
- installation in any orientation

# Flow Monitor Flow Indicator

## DKG



### Operation

The flow monitors and indicators type DKG operate with the float measuring principle



### Application

The flow monitors and indicators type DKG are used for measuring and monitoring the flow of oils and other viscous media.



They are designed in such a way, that also with changes of viscosity, a reliable limit value monitoring is possible. Here the kinematic viscosity may vary between 30 cSt and 600 cSt.

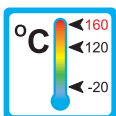

The instruments are predominantly used in lubricant systems.



The instruments are predominantly used in lubricant systems.



Areas of application are:

- Central lubrication
- Circulation lubrication
- Transformers

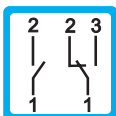

### Features

The DKG series proves itself through reliable function and easy handling. Further characteristics of this sturdy type are:

- universal orientation
- viscosity compensated
- high switch accuracy
- infinitely variable switchpoint adjustment through user
- EX-version to ATEX for DKG-1... available
- Scales are burned into the sight glass
- Threaded connection  
Special threads on request

### Installation hints

The installation of the instrument can be done in any way in the system. The flow direction must be observed.

The instrument must not be used as a supporting part in a pipeconstruction!

The medium must not contain any solid particles!  
We recommend the installation of strainers type SFD or SFM.

External magnetic fields influence the switch contact. Keep adequate distance to those magnetic fields (e.g. electromotors)!

The operating instruction for DKG must be observed under any circumstances!



# Measuring Ranges, Technical Data

## Connection diagram

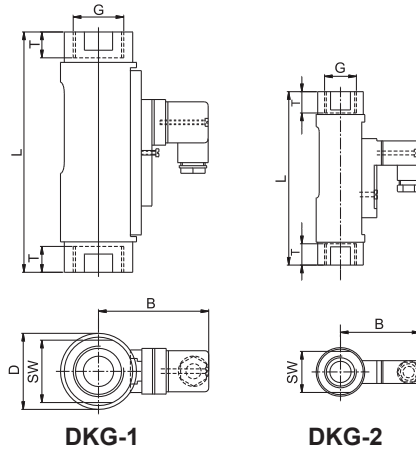
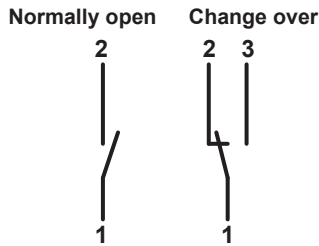

DKG-1

DKG-2

## Summary of types DKG

Type	Switch range* [l/min]	Overall dimensions mm							Weight approx. [g]
		SW	D	B	G	DN	T	L	
DKG-2/2	0,5 - 1,7	27	32	53	1/2"	15	14	114	300
DKG-2/4	1,3 - 4								
DKG-2/8	2,5 - 8								
DKG-1/1	0,1 - 0,8	41	50	77	1/4"	8	17	145	850
DKG-1/2	0,5 - 1,5				1/2"	15		145	
DKG-1/4	1 - 4				3/4"	20		139	
DKG-1/8	2 - 8				1"	25		158	
DKG-1/10	3 - 10	41	50	77	1/2"	15	17	145	850
DKG-1/15	5 - 15				3/4"	20		139	
DKG-1/24	8 - 24				1"	25		158	
DKG-1/30	10 - 30	41	50	77	3/4"	20	17	139	850
DKG-1/45	15 - 45				1"	25		158	
DKG-1/60	20 - 60								
DKG-1/90	30 - 90								

\* Other switch ranges on request

Operating data	DKG-1	DKG-2
Operating pressure:	PN 10 bar	PN 16 bar
Pressure drop:	0,02 - 0,4 bar	0,02 - 0,2 bar
Maximum temperature:	120 °C (optional 160 °C)	
Viscosity range:	30 cSt to 600 cSt	
Accuracy:	±10% of full scale	
Electrical data		
Normally open:	max. 250V • 3A • 100VA	max. 230V • 3A • 60VA
Change over:	max. 250V • 1,5A • 50VA	max. 250V • 1,5A • 50VA
Atex II 2G EEx m II T6 (only for DKG-1)	Change over: 250V • 1A • 30VA, IP67 / Normally open: 250V • 2A • 60 VA, IP67	
EEx m II T6 (only for DKG-1)	Change over: 250V • 1A • 30VA, IP67 / Normally open: 250V • 2A • 60 VA, IP67	
EEx ia IIC T6 (only for DKG-1)	Change over / Normally open: 45V • 1A, IP67	
Ingress Protection:	IP65 (plug connection DIN 43650 Form A or C) IP67 (1m sealed in cable, with EEx-version 2 m)	
Output signal:	The contact opens / changes, when the flow falls below the set point.	
Power supply:	Not required (potentialfree reed contacts)	
Other plug types or cable lengths on request		
Material	Brass	Stainless Steel
Wetted parts:	Brass nickel-plated	1.4571
Sight glass: (wetted part)	Duran 50	Duran 50
Spring: (wetted part)	1.4571	1.4571
Gaskets: (wetted part)	Viton (optional Perbunan, EPDM)*	Viton (optional Perbunan, EPDM)*
Magnets: (wetted part)	Hardferrit	Hardferrit
Housing: (non wetted part)	Aluminium anodized	Aluminium anodized

\* Other gasket materials on request





# Flow Monitor Flow Indicator

## DKM/A



### Operation

The flow monitors and indicators type DKM/A operate with the float measuring principle



### Application

The flow monitors and indicators type DKM/A are used for measuring and monitoring the flow of oils and other viscous media.

They are designed in such a way, that also with changes of viscosity, a reliable limit value monitoring is possible. Here the kinematic viscosity may vary between 30 cSt and 600 cSt.

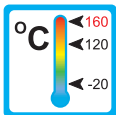

Areas of application are:

- Central lubrication
- Circulation lubrication
- Transformers

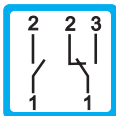

### Features

The DKM/A series proves itself through reliable function and easy handling. Further characteristics of this sturdy type are:

- universal orientation
- high reliability
- viscosity compensated
- high switch accuracy
- infinitely variable switchpoint adjustment through user
- EX-version to ATEX available
- Threaded connection  
Special threads on request
- high pressure resistance

### Installation hints

The installation of the instrument can be done in any way in the system. The flow direction must be observed.

The instrument must not be used as a supporting part in a pipeconstruction!

The medium must not contain any solid particles!  
We recommend the installation of strainers type SFD or SFM.

External magnetic fields influence the switch contact. Keep adequate distance to those magnetic fields (e.g. electromotors)!

The operating instruction for DKM/A must be observed under any circumstances!



# Measuring Ranges, Technical Data

## Connection diagram

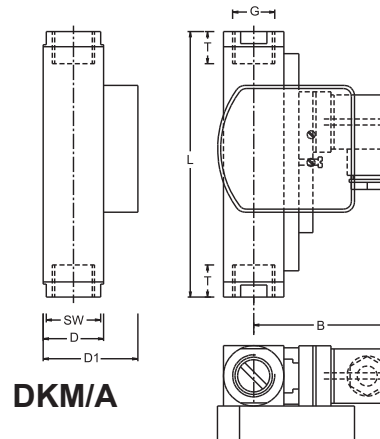
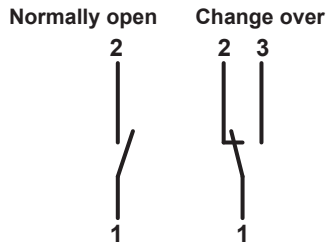

## Summary of types DKM/A

Type	Switch range* [l/min]	Overall dimensions mm								Weight approx. [g]
		SW	D	D1	B	G	DN	T	L	
DKM/A-1/1	0,1 - 0,8	34	40	57	76	1/4"	8	21	152	1590
DKM/A-1/2	0,5 - 1,5	34					15	21	152	1515
DKM/A-1/4	1 - 4	34	40	57	76	3/4"	20	21	152	1430
		40					25	17	130	1250
DKM/A-1/8	2 - 8	34	40	57	76	1/2"	15	21	152	1515
DKM/A-1/10	3 - 10									
DKM/A-1/15	5 - 15	40	40	57	76	3/4"	25	17	130	1250
DKM/A-1/24	8 - 24	40								
DKM/A-1/30	10 - 30	34	40	57	76	3/4"	20	21	152	1430
DKM/A-1/45	15 - 45									
DKM/A-1/60	20 - 60	40	40	57	76	1"	25	17	130	1250
DKM/A-1/90	30 - 90									
DKM/A-1/110	35 - 110	40	40	57	76	1"	25	17	130	1250

\* Other switch ranges on request

Operating data	DKM/A	
Operating pressure:	PN 250 bar (Brass) / PN 300 bar (Stainless Steel)	
Pressure drop:	0,02 - 0,4 bar	
Maximum temperature:	120 °C (optional 160 °C)	
Viscosity range:	30 cSt to 600 cSt	
Accuracy:	±10% of full scale	
Electrical data		
Normally open:	max. 250V • 3A • 100VA	
Change over:	max. 250V • 1,5A • 50VA	
Atex II 2G EEx m II T6	Change over: 250V • 1A • 30VA, IP67 / Normally open: 250V • 2A • 60 VA, IP67	
EEx m II T6	Change over: 250V • 1A • 30VA, IP67 / Normally open: 250V • 2A • 60 VA, IP67	
EEx ia IIC T6	Change over / Normally open: 45V • 1A, IP67	
Ingress Protection:	IP65 (plug connection DIN 43650 Form A) IP67 (1 m sealed in cable, with EEx-version 2 m)	
Output signal:	The contact opens / changes, when the flow falls below the set point.	
Power supply:	Not required (potentialfree reed contacts)	
Other plug types or cable lengths on request		
Material	Brass	Stainless Steel
Wetted parts:	Brass	1.4571
Spring: (wetted part)	1.4571	1.4571
Gaskets: (wetted part)	Viton (optional Perbunan, EPDM)*	Viton (optional Perbunan, EPDM)*
Magnets: (wetted part)	Hardferrit	Hardferrit
Housing: (wetted part)	Brass nickel-plated	1.4571
Display	Makrolon / Brass nickel-plated	

\* Other gasket materials on request



# Flow Monitor

## DKM

### Operation

The flow monitors type DKM operate with the float measuring principle



### Application

The flow monitors type DKM are used for monitoring the flow of oils and other viscous media.



They are designed in such a way, that also with changes of viscosity, a reliable limit value monitoring is possible.

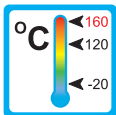

Here the kinematic viscosity may vary between 30 cSt and 600 cSt.



The instruments are predominantly used in lubricant systems.

Areas of application are:



– Central lubrication

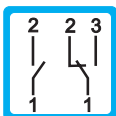

– Circulation lubrication



– Transformers



### Features

The DKM series proves itself through reliable function and easy handling. Further characteristics of this sturdy type are:

- universal orientation
- high reliability
- viscosity compensated
- high switch accuracy
- infinitely variable switchpoint adjustment through user
- EX-version to ATEX available
- Threaded connection  
Special threads on request
- high pressure resistance

### Installation hints

The installation of the instrument can be done in any way in the system. The flow direction must be observed.

The instrument must not be used as a supporting part in a pipe construction!

The medium must not contain any solid particles!  
We recommend the installation of strainers type SFD or SFM.

External magnetic fields influence the switch contact. Keep adequate distance to those magnetic fields (e.g. electromotors)!

The operating instruction for DKM must be observed under any circumstances!



# Measuring Ranges, Technical Data

## Connection diagram

Normally open Change over

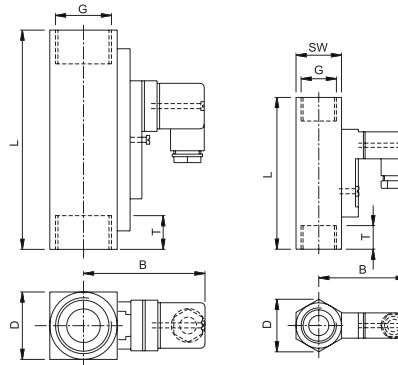
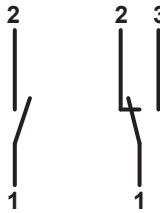

DKM-1

DKM-2

## Summary of types DKM

Type	Switch range* [l/min]	Overall dimensions mm							Weight approx. [g]			
		SW	D	B	G	DN	T	L				
DKM-2/2	0,5 - 1,6	24	31	52	1/4"	8	14	98	400			
		24				10		108	450			
		27				15		90	350			
DKM-2/3	0,8 - 3	27	31	52	1/2"	15	14	90	350			
DKM-2/7	2 - 7											
DKM-1/1	0,1 - 0,8	34	40	76	1/4"	8	21	152	1500			
DKM-1/2	0,5 - 1,5	34				15		152	1425			
DKM-1/4	1 - 4	34				20		152	1340			
		40				25		130	1160			
DKM-1/8	2 - 8	34	40	76	1/2"	15	21	152	1425			
DKM-1/10	3 - 10									20	152	1340
DKM-1/15	5 - 15									25	130	1160
DKM-1/24	8 - 24	40	40	76	3/4"	20	21	152	1340			
DKM-1/30	10 - 30									25	130	1160
DKM-1/45	15 - 45									25	130	1160
DKM-1/60	20 - 60	40	40	76	1"	25	17	130	1160			
DKM-1/90	30 - 90											
DKM-1/110	35 - 110	40	40	76	1"	25	17	130	1160			

\* Other switch ranges on request

Operating data	DKM-1	DKM-2
Operating pressure:	PN 250 bar (Brass) / PN 300 bar (SS)	PN 300 bar (Brass) / PN 350 bar (SS)
Pressure drop:	0,02 - 0,4 bar	0,02 - 0,2 bar
Maximum temperature:	120 °C (optional 160 °C)	
Viscosity range:	30 cSt to 600 cSt	
Accuracy:	±10% of full scale	
Electrical data		
Normally open:	max. 250V • 3A • 100VA	max. 230V • 3A • 60VA
Change over:	max. 250V • 1,5A • 50VA	max. 250V • 1,5A • 50VA
Atex II 2G EEx m II T6	Change over: 250V • 1A • 30VA, IP67 / Normally open: 250V • 2A • 60 VA, IP67	
EEx m II T6	Change over: 250V • 1A • 30VA, IP67 / Normally open: 250V • 2A • 60 VA, IP67	
EEx ia IIC T6	Change over / Normally open: 45V • 1A, IP67	
Ingress Protection:	IP65 (plug connection DIN 43650 Form A or C)	
	IP67 (1 m sealed in cable, with EEx-version 2 m)	
Output signal:	The contact opens / changes, when the flow falls below the set point.	
Power supply:	Not required (potentialfree reed contacts)	
Other plug types or cable lengths on request		
Material	Brass	Stainless Steel
Wetted parts:	Brass	1.4571
Spring: (wetted part)	1.4571	1.4571
Gaskets: (wetted part)	Viton (optional Perbunan, EPDM)*	Viton (optional Perbunan, EPDM)*
Magnets: (wetted part)	Hardferrit	Hardferrit
Housing: (wetted part)	Brass nickel-plated	1.4571

\* Other gasket materials on request



# Flow Monitor

## DKME



### Operation

The flow monitors type DKME operate with the float measuring principle



### Application

The flow monitor type DKME are used for monitoring the flow of oils and other viscous media.



They are designed in such a way, that also with changes of viscosity, a reliable limit value monitoring is possible.

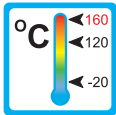

Here the kinematic viscosity may vary between 30 cSt and 600 cSt.



The instruments are predominantly used in lubricant systems.

Areas of application are:



– Central lubrication

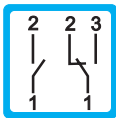

– Circulation lubrication



– Transformers



### Features

The DKME series proves itself through reliable function and easy handling. Further characteristics of this sturdy type are:

- universal mounting
- high reliability
- viscosity compensated
- high switch accuracy
- wide switch range
- infinitely variable switchpoint adjustment through user
- EX-version to ATEX available
- high pressure resistance

### Installation hints

The installation of the flow monitor can be done in any way in the system. The flow direction must be observed.

The flow monitor must not be used as a supporting part in a pipeconstruction!

The medium must not contain any solid particles! We recommend the installation of strainers type SFD or SFM.

External magnetic fields influence the switch contact. Keep adequate distance to those magnetic fields (e.g. electromotors)!

The operating instruction for DKME must be observed under any circumstances!



# Measuring Ranges, Technical Data

## Connection diagram

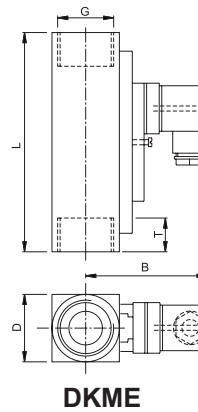
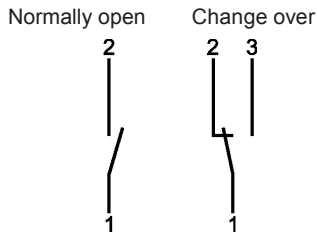

## Summary of types DKME

Type	Switch range* [l/min]	Overall dimensions [mm]							Weight approx. [g]
		SW	D	B	G	DN	T	L	
DKME - 1/20	1 - 20	34	40	76	1/2"	15	21	152	1425
DKME - 1/40	4 - 40	34				20	21	152	1340
		40			1"	25	17	130	1160
DKME - 1/50	5 - 50	34	40	76	3/4"	20	21	152	1340
DKME - 1/60	8 - 60	40				25	17	130	1160
DKME - 1/70	12 - 70	40	40	76	1"	25	17	130	1160
DKME - 1/80	15 - 80								

\* for mineral oil with kinematic viscosity between 30 and 600 cSt, other switch ranges on request

Operating data	DKME	
Operating pressure:	PN 250 bar (Brass)	PN 300 bar (Stainless steel)
Pressure drop:	0,02 - 0,4 bar	
Maximum temperature:	120°C (optional 160°C)	
Accuracy:	10% of full scale	
<b>Electrical data:</b>	<b>Normally open</b>	<b>Change over</b>
IP 65 (plug connection DIN 43650 Form A)	max. 250V • 3A • 100VA	max. 250V • 1,5A • 50VA
IP 67 (1m sealed in cable)		
Atex II 2G EEx m II T6 (2m sealed in cable)	max. 250V • 2A • 60VA	max. 250V • 1A • 30VA
EEx m II T6 (2m sealed in cable)	max. 250V • 2A • 60VA	max. 250V • 1A • 30VA
EEx ia IIC T6 (2m sealed in cable)	max. 45V • 1A	max. 45V • 1A
Output signal:	The contact opens / changes, when the flow falls below the set point.	
Power supply:	Not required (potentialfree reed contact)	
Other plug types or cable lengths on request		
<b>Material:</b>	<b>Brass</b>	<b>Stainless steel</b>
Wetted parts:	Brass	1.4571
Spring: (wetted part)	1.4571	
Magnets: (wetted part)	Hardferrit	
Housing: (wetted part)	Brass nickel-plated	1.4571

DKME 2 0001 05-04 E.M





# Flow Monitor Flow Indicator

## DKME/A



### Operation

The flow monitors and indicators type DKME/A operate with the float measuring principle



### Application

The flow monitors and indicators type DKME/A are used for measuring and monitoring the flow of oils and other viscous media.

They are designed in such a way, that also with changes of viscosity, a reliable limit value monitoring is possible. Here the kinematic viscosity may vary between 30 cSt and 600 cSt.

The instruments are predominantly used in lubricant systems.

Areas of application are:

- Central lubrication
- Circulation lubrication
- Transformers

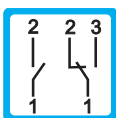
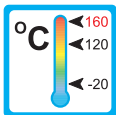

### Features

The DKME/A series proves itself through reliable function and easy handling. Further characteristics of this sturdy type are:

- universal mounting
- high reliability
- viscosity compensated
- high switch accuracy
- wide switch range
- infinitely variable switchpoint adjustment through user
- EX-version to ATEX available
- high pressure resistance

### Installation hints

The installation of the flow monitor can be done in any way in the system. The flow direction must be observed.

The flow monitor must not be used as a supporting part in a pipeconstruction!

The medium must not contain any solid particles! We recommend the installation of strainers type SFD or SFM.

External magnetic fields influence the switch contact. Keep adequate distance to those magnetic fields (e.g. electromotors)!

The operating instruction for DKME/A must be observed under any circumstances!

DKME/A 1 0001 05-04 E M





# Measuring Ranges, Technical Data

## Connection diagram

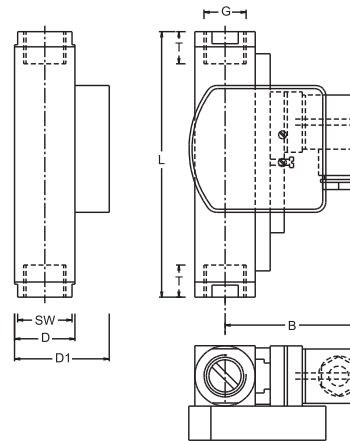
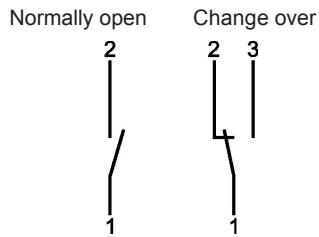

DKME/A

## Summary of types DKME/A

Type	Switch range* [l/min]	Overall dimensions [mm]								Weight approx. [g]
		SW	D	D1	B	G	DN	T	L	
DKME/A - 1/20	1 - 20	34	40	57	76	1/2"	15	21	152	1510
DKME/A - 1/40	4 - 40	34					20	21	152	1425
DKME/A - 1/50	5 - 50	40	40	57	76	3/4"	25	17	130	1245
DKME/A - 1/60	8 - 60	40					20	21	152	1425
DKME/A - 1/70	12 - 70	40	40	57	76	1"	25	17	130	1245
DKME/A - 1/80	15 - 80	40					25	17	130	1245

\* for mineral oil with kinematic viscosity between 30 and 600 cSt, other switch ranges on request

Operating data	DKME/A	
Operating pressure:	PN 250 bar (Brass)	PN 300 bar (Stainless steel)
Pressure drop:	0,02 - 0,4 bar	
Maximum temperature:	120 °C (optional 160 °C)	
Accuracy:	10% of full scale	
<b>Electrical data:</b>	<b>Normally open</b>	<b>Change over</b>
IP 65 (plug connection DIN 43650)	max. 250V • 3A • 100VA	max. 250V • 1,5A • 50VA
IP 67 (1m sealed in cable)		
Atex II 2G EEx m II T6 (2m sealed in cable)	max. 250V • 2A • 60VA	max. 250V • 1A • 30VA
EEx m II T6 (2m sealed in cable)	max. 250V • 2A • 60VA	max. 250V • 1A • 30VA
EEx ia IIC T6 (2m sealed in cable)	max. 45V • 1A	max. 45V • 1A
Output signal:	The contact opens / changes, when the flow falls below the set point.	
Power supply:	Not required (potentialfree reed contact)	
Other plug types or cable lengths on request		
<b>Material:</b>	<b>Brass</b>	<b>Stainless steel</b>
Wetted parts:	Brass	1.4571
Spring: (wetted part)	1.4571	
Magnets: (wetted part)	Hardferrit	
Housing: (wetted part)	Brass nickel-plated	1.4571

DKME/A 2 0001 05-04 E.M



## Flowmeters and flow monitor in plastic

Types: KM 10/KM 11/KM 12/KM 13, KM 16/KM 17/KM 18/KM 20,  
KM 35, RVP/U

# 5

### KM 10 - KM 13



#### Flowmeter in plastic for liquids

- large measuring range
- high accuracy
- optional flow regulating
- thread connection

### KM 16 - KM 20



#### Flowmeter in plastic for liquids and gases

- large measuring range
- materials to suit applications
- optional analog output

### KM 35

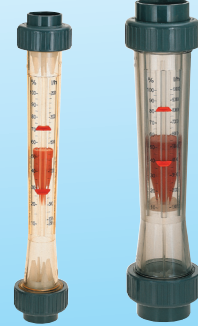

#### Flowmeter in plastic for liquids and gases

- large measuring range
- materials to suit applications
- optional analog output

### RVP/U

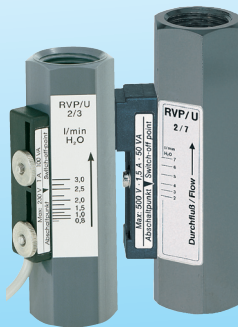

#### Flow monitor in plastic for liquids

- small physical size
- sturdy construction
- installation in any orientation

# PMMA-Flowmeters

## KM 10, KM 11 KM 12, KM 13

### Operation

The flowmeters type KM 10 to KM 13 operate with the float measuring principle

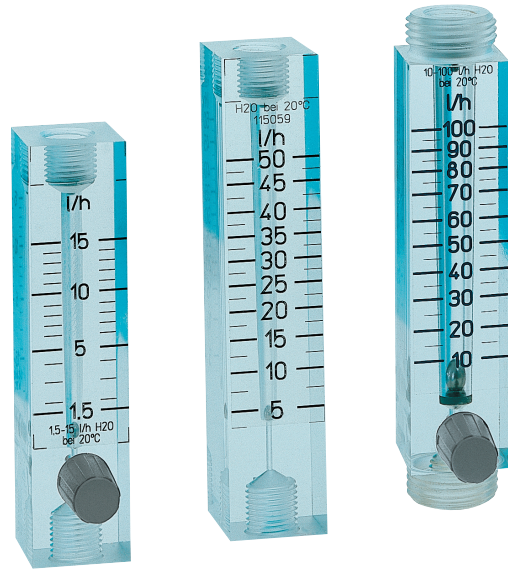

### Application

The flowmeters type KM 10 to KM 13 are used for measuring volumeflow of liquid media. The types KM 10 and KM 13 also allow to adjust the flow-rate .

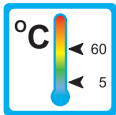

Areas of application for example:



- Mechanical Engineering
- Medicine technology
- Pharma industry
- Chemical industry
- Research and development

### Features

The series proves itself through reliable function and easy handling. Further characteristics are:

- high accuracy ( $\pm 2\%$  of full scale)
- easy to read
- Flow regulation easy to handle (KM 10 and KM 13)
- Threaded connection  
Internal thread (KM 10 and KM 11)  
Internal- and External thread (KM 12 and KM 13)

### Installation hints

The instrument must be installed vertically in the flow circuit. The flowdirection is from bottom to top.

The flowmeter must not be used as a supporting part in a pipeconstruction!

The medium must not contain any solid particles!



# Technical data

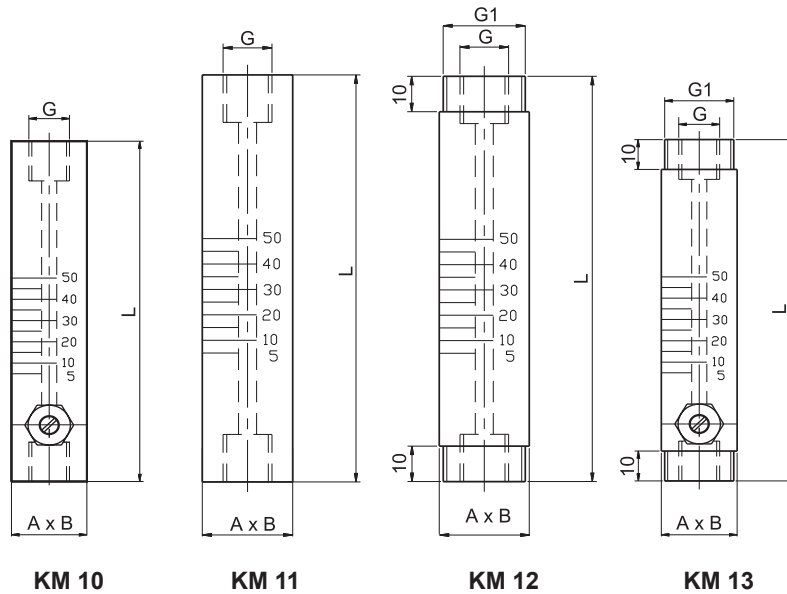

Type	Measuring range [l/h]	Overall dimensions mm			
		L	A x B	G	G1
KM 10-15	1,5 - 15	105	25 x 25	1/4"	—
KM 10-25	2,5 - 25	120	25 x 25	1/4"	—
KM 10-50	5 - 50	120	25 x 25	1/4"	—
KM 10-100	10 - 100	120	25 x 25	1/4"	—
KM 11-15	1,5 - 15	105	25 x 25	1/4"	—
KM 11-25	2,5 - 25	120	25 x 25	1/4"	—
KM 11-50	5 - 50	120	25 x 25	1/4"	—
KM 11-100	10 - 100	120	25 x 25	1/4"	—
KM 12-15	1,5 - 15	105	25 x 25	1/4"	5/8"
KM 12-25	2,5 - 25	120	25 x 25	1/4"	5/8"
KM 12-50	5 - 50	120	25 x 25	1/4"	5/8"
KM 12-100	10 - 100	120	25 x 25	1/4"	5/8"
KM 13-15	1,5 - 15	105	25 x 25	1/4"	5/8"
KM 13-25	2,5 - 25	120	25 x 25	1/4"	5/8"
KM 13-50	5 - 50	120	25 x 25	1/4"	5/8"
KM 13-100	10 - 100	120	25 x 25	1/4"	5/8"

Operating data	KM 10	KM 11	KM 12	KM 13
Operating pressure	PN 10			
Temperature range	5 °C - 60 °C			
Accuracy	± 2% of full scale			
Flow regulation	yes	no	no	yes
<b>Material</b>				
Housing (wetted part)	PMMA (Acrylic glass)			
Float (wetted part)	Stainless steel 1.4301			
Flow regulation	PVC, 1.4301	—	—	PVC, 1.4301

KM10 2 0001 05-04 E M



# Synthetic VA Flowmeters

## KM 16, KM 17 KM 18, KM 20

### Operation

The flowmeters type KM 16 to KM 20 operate with the float measuring principle



### Application

The flowmeters type KM 16 to KM 20 are used for measuring volumeflow of liquid and gaseous media.



Areas of application:

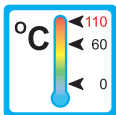

– Coolingsystems and cooling-circuits



– Mechanical Engineering  
e.g. Weldingmachinery,  
Laserplants



– Medicine technology

– Pharmaceutical industry

– Research and development

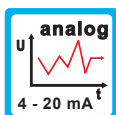
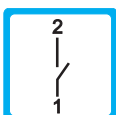

### Features

The model proves itself through reliable function and easy handling:

- high accuracy (Accuracy class 4)
- easy to read
- Good suitability for special media by choice between 4 different materials
- Scales can be exchanged subsequently, Special scales on request
- Glue connections or threaded connections

### Installation hints

The instrument must be installed vertically in the flow circuit. The flowdirection is from bottom to top.

The flowmeter must not be used as a supporting part in a pipeconstruction!

The medium must not contain any solid particles!

KM16 1 0002 07-04 E M



# Technical Data

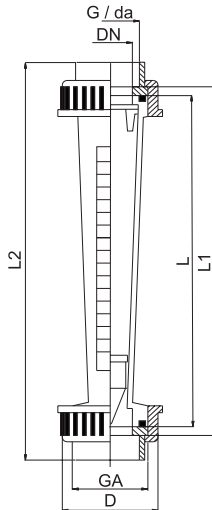

Material				
	Version PVC-U	Version PA	Version PSU	Version PVDF
Measuring tube	PVC-U	PA	PSU	PVDF
Float	PVDF*	PVDF*	PVDF*	PVDF*
Connection				
Glue connection	PVC			
Treaded connection				
standard:	PVC			
optional:	GTW, Brass, Stainless steel (1.4571)			

Standard exworks are glue connections.

\*optional liquidtight encapsulated magnets (Recording of measurement)

Other versions on request!

Type	Measuring range H <sub>2</sub> O [l/h]	Overall dimensions mm							Option G	Weight [g]
		da	DN	L	L1	L2	D	GA		
KM 16-02	3 - 24	16	10	165	171	199	35	3/4"	3/8"	78
KM 16-06	5 - 60	16	10	165	171	199	35	3/4"	3/8"	78
KM 16-1	10 - 100	16	10	165	171	199	35	3/4"	3/8"	78
KM 16 -2.5	25 - 250	16	10	165	171	199	35	3/4"	3/8"	78
KM 17-05	5 - 50	20	15	170	176	208	43	1"	1/2"	96
KM 17-1.5	15 - 150	20	15	170	176	208	43	1"	1/2"	96
KM 17-2.5	25 - 250	20	15	170	176	208	43	1"	1/2"	96
KM 17-4	40 - 400	20	15	170	176	208	43	1"	1/2"	96
KM 18-1.5	15 - 150	25	20	185	191	229	53	1 1/4"	3/4"	125
KM 18-4	40 - 400	25	20	185	191	229	53	1 1/4"	3/4"	125
KM 18-6	60 - 600	25	20	185	191	229	53	1 1/4"	3/4"	125
KM 18-10	100 - 1000	25	20	185	191	229	53	1 1/4"	3/4"	125
KM 20-2.5	25 - 250	32	25	200	206	250	60	1 1/2"	1"	250
KM 20-4	40 - 400	32	25	200	206	250	60	1 1/2"	1"	250
KM 20-10	100 - 1000	32	25	200	206	250	60	1 1/2"	1"	250
KM 20-15	150 - 1500	32	25	200	206	250	60	1 1/2"	1"	250

Technical data	KM-16	KM-17	KM-18	KM-20
Operating pressure max.:	see Pressure - Temperature - Diagram			
Pressure drop:	see table on page 3			
Temperature range:				
PVC-U	-10 bis +60 °C			
PA	+5 bis +75 °C			
PSU	+5 bis +100 °C			
PVDF	0 bis +110 °C			
Accuracy:	Accuracy class 4 according to VDE / VDI 3513 page 2			

## Pressure - Temperature - Diagram

The curves of the diagram present approximate values of the resistance of four different materials in relation to the operating temperature.

Pressure - temperature curves are valid for a calculated life - time of 20 years.

Among other factors the creep strength of the different materials must be considered when determining the permissible operating pressure.

As far as these details or operating temperatures under 0 °C are concerned, we ask you to inform us about the exact operating conditions.

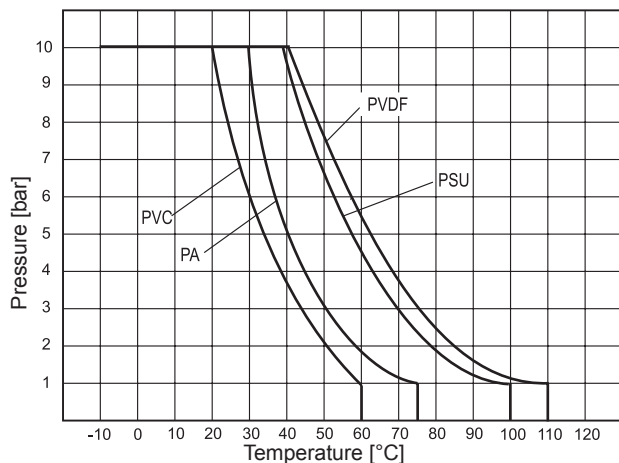

KM16 2 0002 07-04 E M



## Measuring ranges for water and air

Type	Range H <sub>2</sub> O [l/h]	Pressure drop H <sub>2</sub> O at 20 °C [mbar]	Range Air, 20 °C, 0 - 0,2 bar rel. [Nm <sup>3</sup> /h]	Pressure drop Air at 20 °C [mbar]
KM 16-02	3 - 24	3,3	0,2 - 1,0	4,8
KM 16-06	5 - 60	3,3	0,2 - 3,2	4,8
KM 16-1	10 - 100	3,3	0,5 - 3,6	4,8
KM 16 -2.5	25 - 250	3,3	0,5 - 9,0	4,8
KM 17-05	5 - 50	2,5	0,4 - 2,8	4,3
KM 17-1.5	15 - 150	2,5	0,8 - 6,25	4,3
KM 17-2.5	25 - 250	2,5	0,9 - 9,5	4,3
KM 17-4	40 - 400	2,5	2,0 - 15,0	4,3
KM 18-1.5	15 - 150	6,1	0,5 - 5,5	8,3
KM 18-4	40 - 400	6,1	2,0 - 14,0	8,3
KM 18-6	60 - 600	6,1	2,5 - 22,0	8,3
KM 18-10	100 - 1000	6,1	4,0 - 34,0	8,3
KM 20-2.5	25 - 250	6,1	1,0 - 8,0	8,3
KM 20-4	40 - 400	6,1	2,0 - 14,0	8,3
KM 20-10	100 - 1000	6,1	4,0 - 34,0	8,3
KM 20-15	150 - 1500	6,1	5,0 - 50,0	8,3

Type	Range Air 1 bar [Nm <sup>3</sup> /h]	Range Air 2 bar [Nm <sup>3</sup> /h]	Range Air 3 bar [Nm <sup>3</sup> /h]	Range Air 4 bar [Nm <sup>3</sup> /h]	Range Air 5 bar [Nm <sup>3</sup> /h]	Range Air 6 bar [Nm <sup>3</sup> /h]	Range Air 7 bar [Nm <sup>3</sup> /h]	Range Air 8 bar [Nm <sup>3</sup> /h]
KM 16-02	0,2 - 1,3	0,25 - 1,6	0,3 - 1,75	0,3 - 1,9	0,3 - 2,1	0,3 - 2,2		0,3 - 2,3
KM 16-06	0,4 - 3,2	0,2 - 3,8	0,3 - 4,4	0,3 - 4,8	0,3 - 5,1	0,25 - 5,25	0,4 - 5,8	0,3 - 6,0
KM 16-1	0,6 - 5,0	0,8 - 6,0	0,8 - 7,0	0,8 - 7,8	0,8 - 8,0	1,0 - 8,7		1,0 - 9,0
KM 16 -2.5	1,0 - 13,0	1,0 - 16,0	1,5 - 18,0	1,5 - 20,0	2,0 - 23,5	2,0 - 26,0		
KM 17-05	0,2 - 3,2	0,5 - 4,0	0,5 - 4,5	0,3 - 4,6	0,5 - 5,5	0,5 - 5,5		0,5 - 6,5
KM 17-1.5	1,0 - 9,0	1,0 - 11,0	1,5 - 12,0	1,0 - 13,0	1,5 - 15,0	1,5 - 16,0	2,0 - 17,0	2,0 - 18,0
KM 17-2.5	1,5 - 13,0	1,5 - 17,0	2,0 - 20,0	1,5 - 22,0	2,0 - 23,5	4,0 - 26,0	2,0 - 28,0	
KM 17-4	2,0 - 21,0	3,0 - 26,0	3,0 - 30,0	3,0 - 33,0	3,0 - 36,0	4,0 - 40,0		
KM 18-1.5	1,0 - 8,5	1,0 - 11,0	1,0 - 10,5	1,5 - 13,5	1,5 - 15,0	1,0 - 12,0		
KM 18-4	2,0 - 20,0	3,0 - 26,0	4,0 - 30,0	3,0 - 33,0	4,0 - 36,0	4,0 - 38,5		4,0 - 40,0
KM 18-6	4,0 - 31,0	4,0 - 38,0	5,0 - 45,0	5,0 - 48,0	6,0 - 54,0	5,0 - 57,5		6,0 - 66,0
KM 18-10	5,0 - 45,0	6,0 - 58,0	7,5 - 67,5	7,5 - 72,5	8,0 - 80,0	10,0 - 90,0	10,0 - 100	
KM 20-2.5	1,5 - 13,0	1,5 - 16,0	1,5 - 17,0	2,0 - 18,0	2,0 - 19,0	2,0 - 20,0		
KM 20-4	2,0 - 20,0	3,0 - 26,0	3,0 - 30,0	3,0 - 33,0	4,0 - 34,0	4,0 - 38,5		
KM 20-10	4,0 - 46,0	5,0 - 55,0	6,0 - 66,0	7,5 - 72,5	8,0 - 80,0	8,0 - 90,0	7 - 95	
KM 20-15	6,0 - 70,0	7,5 - 90,0	7,5 - 100	10,0 - 120	10,0 - 130	10,0 - 140	10 - 150	

The measuring ranges indicated in the table are approximate values at 20 °C.

Other measuring ranges and gases on request!

**Caution: Do not use PVC - measuring tubes with Air / Gas - Application !**

KM16 3 0001 07-04 E.M





# Limitswitch, Measuring Sensor

## Limitswitch SG-KM

The limitswitches SG-KM serve as event marker for min., max. or any inbetween value of the flow. They are fitted on the dove-tail of the measuring tube and trigger a signal when the float reaches or passes the switch. As soon as this happens the reed contact opens or closes. For this function the float must contain magnets.



SG-KM

### Type SG-KM-MO-S monostable (normally open)

The contact is closed, when the float is in line with the limitswitch. It opens (event) as soon as the float moves up or down away from the switch, which means increasing or decreasing flow.

### Type SG-KM-BI-S/Ö bistable (normally open or normally closed)

The normally open contact closes as soon as the magnetfloat approaches (coming from the bottom) the limitswitch or is in line with the same. When overriding the limitswitch, the switchcondition remains. Only when overriding the limitswitch, the switchcondition will be cancelled.

The normally closed contact is closed under noflow condition and open under flow condition.

Remark: Before the first start up, the float has to pass the limitswitch at least 3 times in order to cancel the monostable behaviour!

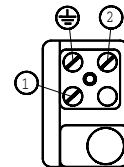

### Connection allocation

The polarity of the connectors does not influence the function

Technical Data			
<b>Operating voltage:</b>	max. 470 V AC	<b>Operating temperature:</b>	0 °C bis +55 °C
<b>Switch current:</b>	max. 0,5 A	<b>Ingress protection:</b>	IP 65 (DIN 40050)
<b>Switch power:</b>	max. 10 W / 10VA	<b>Hysteresis:</b>	3 mm
<b>Switch resistance:</b>	< 150 mΩ	<b>Dimensions:</b>	34 x 17 x 41 mm
<b>Insulating resistance:</b>	> 10 <sup>11</sup> Ω	<b>Weight (incl. plug):</b>	40 g

The electrical max. values must not be exceeded!

## Measuring Sensor KME-16/35

The measuring sensor KME-16/35 detects, by means of magnetic sensors, the actual position of the magnetic float in the measuring tube of the flowmeters.

The position of the float is touchless detected within the flowrange from 10 to 100 % with a resolution of 0,1% and transmitted as analog signal of 4 - 20 mA and/or digital signal via RS 232 - interface.

The new sensor technique can be programmed for different media and operating conditions.

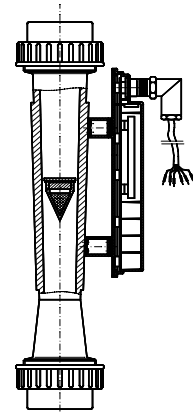

KME-16/35

Allocation and connecting diagram	
Pin 1 = 24 V DC (+)	
Pin 2 = Gnd (-)	
Pin 3 = I <sub>OUT</sub> (+) Analog output 4...20 mA, load ≤ 1 kΩ	
Pin 4 = I <sub>OUT</sub> (-) Analog output 4...20 mA	
Pin 5 = TxD (transmitting) Digital output	
Pin 6 = RxD (receiving) Digital output	
Pin 5 and Pin 6: RS 232 - Interface with TTL-level Data format : 9600 Baud, 8 Databits, 1 Stopbit, No Parity	

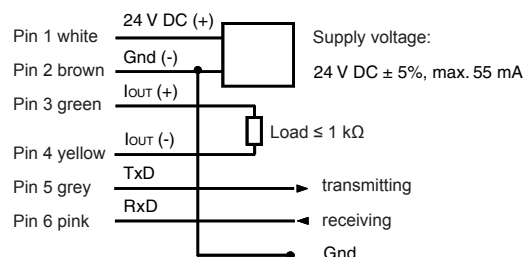

Technical Data			
<b>Supply voltage:</b>	24 V DC	<b>Operating temperature:</b>	0 °C bis +55 °C
<b>Input current:</b>	max. 55 mA	<b>Ingress protection:</b>	IP 65 (DIN 40050)
<b>direct Analog output:</b>	4... 20 mA	<b>Accuracy:</b>	± 1 % of actual value
<b>direct Digital output:</b>	RS 232	<b>Repeatability:</b>	0,2 % (over entire Range)
<b>Connection:</b>	6-pin plug	<b>Material:</b>	Thermoplastics

The analog inputs of instruments, which are connected to the analog output of the KME-16/35, must not be on operating voltage potential. Only instruments with galvanic isolated inputs must be used.

The max. cable length (w/o amplifier) is 2 m when using the RS 232 - interface and 20 m with the analog output.

An EPROM, inside the KME-16/35, is burnt for each individual application, therefore all medium specific data, which are necessary for special scaling, must be supplied with the order (concentration, viscosity, density).



# Synthetic VA Flowmeters

## KM 35

### Operation

The flowmeters type KM 35 operate with the float measuring principle



### Application

The flowmeters type KM 35 are used for measuring volumeflow of liquid and gaseous media.



Areas of application:

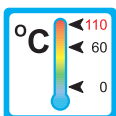

– Mechanical Engineering  
e.g. Weldingmachinery,  
Laserplants



– Medicine technology



– Pharmaceutical industry



– Research and development

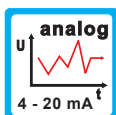
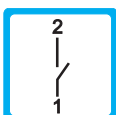

### Features

The model proves itself through reliable function and easy handling:

- high accuracy (Accuracy class 4)
- easy to read
- Good suitability for special media by choice between 4 different materials
- Scales can be exchanged subsequently, Special scales on request
- Glue connections or threaded connections

### Installation hints

The instrument must be installed vertically in the flow circuit. The flowdirection is from bottom to top.

The flowmeter must not be used as a supporting part in a pipeconstruction!

The medium must not contain any solid particles!

KM35 1 0001 07-04 E M



# Technical Data

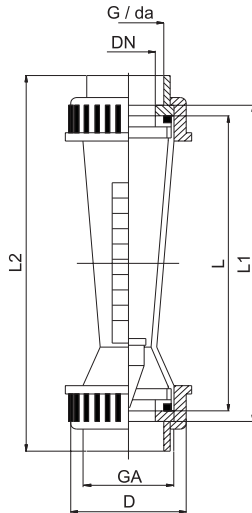

Material				
	Version PVC-U	Version PA	Version PSU	Version PVDF
Measuring tube	PVC-U	PA	PSU	PVDF
Float	PVDF*	PVDF*	PVDF*	PVDF*
Connection				
Glue connection	PVC			
Threaded connection				
standard:	PVC			
optional:	GTW, Brass, Stainless steel (1.4571)			

Standard exworks are glue connections.

\*optional liquidtight encapsulated magnets (Recording of measurement)

Other versions on request!

Type	Measuring range H <sub>2</sub> O [l/h]	Overall dimensions mm							Option G	Weight [g]
		da	DN	L	L1	L2	D	GA		
KM 35-1,5	15 - 150	32	25	350	356	400	60	1 1/2"	1"	475
KM 35-3	30 - 300	32	25	350	356	400	60	1 1/2"	1"	475
KM 35-6	60 - 600	32	25	350	356	400	60	1 1/2"	1"	475
KM 35-10	100 - 1000	32	25	350	356	400	60	1 1/2"	1"	475
KM 35-15	150 - 1500	40	32	350	356	408	72	2"	1 1/4"	710
KM 35-20	200 - 2000	50	40	350	356	418	83	2 1/4"	1 1/2"	1050
KM 35-25	250 - 2500	40	32	350	356	408	72	2"	1 1/4"	710
KM 35-30	300 - 3000	50	40	350	356	418	83	2 1/4"	1 1/2"	1050
KM 35-40	400 - 4000	63	50	350	356	432	103	2 3/4"	2"	1530
KM 35-60	600 - 6000	63	50	350	356	432	103	2 3/4"	2"	1530
KM 35-100	1000 - 10000	63	50	350	356	432	103	2 3/4"	2"	1530
KM 35-150	1500 - 15000	75	65	350	356	444	122	3 1/2"	2 1/2"	2100
KM 35-250	2500 - 25000	75	65	350	356	444	122	3 1/2"	2 1/2"	2100

Technical data	KM 35	
Operating pressure max.:	see Pressure - Temperature - Diagram	
Pressure drop:	see table on page 3	
Temperature range:		
PVC-U	-10	bis +60 °C
PA	+5	bis +75 °C
PSU	+5	bis +100 °C
PVDF	0	bis +110 °C
Accuracy:	Accuracy class 4 according to VDE / VDI 3513 page 2	

## Pressure - Temperature - Diagram

The curves of the diagram present approximate values of the resistance of four different materials in relation to the operating temperature.

Pressure - temperature curves are valid for a calculated life - time of 20 years.

Among other factors the creep strength of the different materials must be considered when determining the permissible operating pressure.

As far as these details or operating temperatures under 0 °C are concerned, we ask you to inform us about the exact operating conditions.

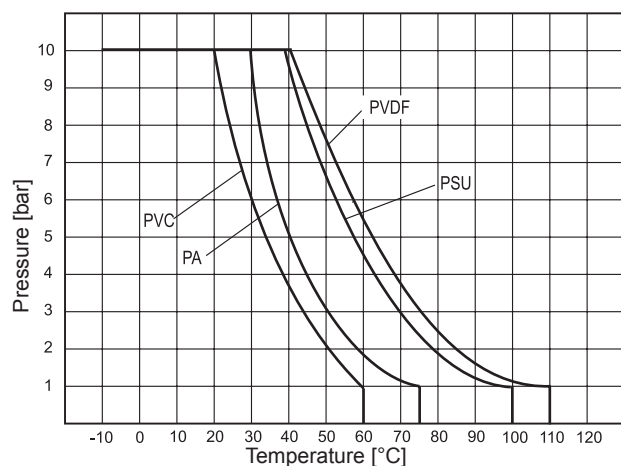

KM35 2 0001 07-04 E M



## Measuring ranges for water and air

Type	Range H <sub>2</sub> O [l/h]	Pressure drop H <sub>2</sub> O at 20 °C [mbar]	Range Air, 20 °C, 0 - 0,2 bar rel. [Nm <sup>3</sup> /h]	Pressure drop Air at 20 °C [mbar]
KM 35-1,5	15 - 150	12,3	0,6 - 5,7	15,9
KM 35-3	30 - 300	12,3	1,0 - 10	15,9
KM 35-6	60 - 600	12,3	2,0 - 21	15,9
KM 35-10	100 - 1000	12,3	3,0 - 34	15,9
KM 35-15	150 - 1500	12,3	5,0 - 50	15,9
KM 35-20	200 - 2000	12,3	8,0 - 70	15,9
KM 35-25	250 - 2500	12,3	7,0 - 80	15,9
KM 35-30	300 - 3000	12,3	10 - 100	15,9
KM 35-40	400 - 4000	22,2	14 - 125	27,1
KM 35-60	600 - 6000	22,2	20 - 200	27,1
KM 35-100	1000 - 10000	22,2	30 - 320	27,1
KM 35-150	1500 - 15000	33,7	50 - 500	40,0
KM 35-250	2500 - 25000	33,7	80 - 800	40,0
KM 35-500	10000 - 50000	33,7	300 - 1600	40,0

Type	Range Air 1 bar [Nm <sup>3</sup> /h]	Range Air 2 bar [Nm <sup>3</sup> /h]	Range Air 3 bar [Nm <sup>3</sup> /h]	Range Air 4 bar [Nm <sup>3</sup> /h]	Range Air 5 bar [Nm <sup>3</sup> /h]	Range Air 6 bar [Nm <sup>3</sup> /h]	Range Air 7 bar [Nm <sup>3</sup> /h]	Range Air 8 bar [Nm <sup>3</sup> /h]
KM 35-1,5	1,0 - 7,5	0,8 - 11	1,0 - 10,5	1,0 - 11	1,0 - 13	1,0 - 13	1,2 - 14	1,0 - 15
KM 35-3	1,5 - 14	2,0 - 18	2,0 - 20	2,0 - 22	2,0 - 24	2,0 - 26	3,0 - 28	3,0 - 30
KM 35-6	3,0 - 30	4,0 - 36	4,0 - 40	5,0 - 45	5,0 - 50	5,0 - 55	6,0 - 58	6,0 - 60
KM 35-10	5,0 - 50	5,0 - 60	5,0 - 70	6,0 - 75	10 - 84	10 - 90	10 - 96	7 - 100
KM 35-15	5,0 - 70	7,0 - 85	8,0 - 100	10 - 110	10 - 120	10 - 130	10 - 140	10 - 150
KM 35-20	10 - 100	10 - 120	12 - 135	20 - 150	15 - 170	15 - 180	20 - 190	15 - 200
KM 35-25	10 - 110	10 - 140	15 - 160	15 - 180	20 - 200	22 - 200	24 - 215	20 - 240
KM 35-30	15 - 140	20 - 160	20 - 190	20 - 220	20 - 240	30 - 260	30 - 280	30 - 280
KM 35-40	20 - 170	15 - 220	20 - 250	31 - 275	20 - 320	30 - 320	20 - 360	40 - 380
KM 35-60	30 - 280	30 - 380	40 - 400	50 - 500	50 - 500	60 - 520	60 - 580	60 - 580
KM 35-100	40 - 440	50 - 540	60 - 620	70 - 700	70 - 800	80 - 820	80 - 900	100 - 950
KM 35-150	80 - 700	80 - 800	102 - 880	114 - 980	125 - 1070	100 - 1300	144 - 1240	153 - 1300
KM 35-250	100 - 1200	140 - 1240	166 - 1400	185 - 1600	200 - 1750	220 - 1880	220 - 2200	250 - 2100
KM 35-500	400 - 2200	600 - 2500	700 - 2900	800 - 3200	800 - 3800	900 - 4000	1050 - 4100	1100 - 4300

The measuring ranges indicated in the table are approximate values at 20 °C.  
Other measuring ranges and gases on request.

**Caution: Do not use PVC - measuring tubes with Air / Gas - Application !**

KM35 3 0001 07-04 E M



# Limitswitch, Measuring Sensor

## Limitswitch SG-KM

The limitswitches SG-KM serve as event marker for min., max. or any inbetween value of the flow. They are fitted on the dove-tail of the measuring tube and trigger a signal when the float reaches or passes the switch. As soon as this happens the reed contact opens or closes. For this function the float must contain magnets.



SG-KM

### Type SG-KM-MO-S monostable (normally open)

The contact is closed, when the float is in line with the limitswitch. It opens (event) as soon as the float moves up or down away from the switch, which means increasing or decreasing flow.

### Type SG-KM-BI-S/Ö bistable (normally open or normally closed)

The normally open contact closes as soon as the magnetfloat approaches (coming from the bottom) the limitswitch or is in line with the same. When overriding the limitswitch, the switchcondition remains. Only when overriding the limitswitch, the switchcondition will be cancelled.

The normally closed contact is closed under noflow condition and open under flow condition.

Remark: Before the first start up, the float has to pass the limitswitch at least 3 times in order to cancel the monostable behaviour!

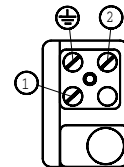

### Connection allocation

The polarity of the connectors does not influence the function

Technical Data			
<b>Operating voltage:</b>	max. 470 V AC	<b>Operating temperature:</b>	0 °C bis +55 °C
<b>Switch current:</b>	max. 0,5 A	<b>Ingress protection:</b>	IP 65 (DIN 40050)
<b>Switch power:</b>	max. 10 W / 10VA	<b>Hysteresis:</b>	3 mm
<b>Switch resistance:</b>	< 150 mΩ	<b>Dimensions:</b>	34 x 17 x 41 mm
<b>Insulating resistance:</b>	> 10 <sup>11</sup> Ω	<b>Weight (incl. plug):</b>	40 g

The electrical max. values must not be exceeded!

## Measuring Sensor KME-16/35

The measuring sensor KME-16/35 detects, by means of magnetic sensors, the actual position of the magnetic float in the measuring tube of the flowmeters.

The position of the float is touchless detected within the flowrange from 10 to 100 % with a resolution of 0,1% and transmitted as analog signal of 4 - 20 mA and/or digital signal via RS 232 - interface.

The new sensor technique can be programmed for different media and operating conditions.

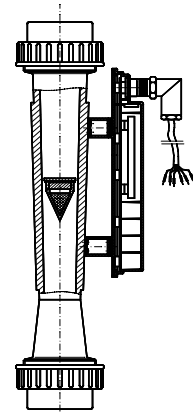

KME-16/35

Allocation and connecting diagram	
Pin 1 = 24 V DC (+)	
Pin 2 = Gnd (-)	
Pin 3 = I <sub>OUT</sub> (+) Analog output 4...20 mA, load ≤ 1 kΩ	
Pin 4 = I <sub>OUT</sub> (-) Analog output 4...20 mA	
Pin 5 = TxD (transmitting) Digital output	
Pin 6 = RxD (receiving) Digital output	
Pin 5 and Pin 6: RS 232 - Interface with TTL-level Data format : 9600 Baud, 8 Databits, 1 Stopbit, No Parity	

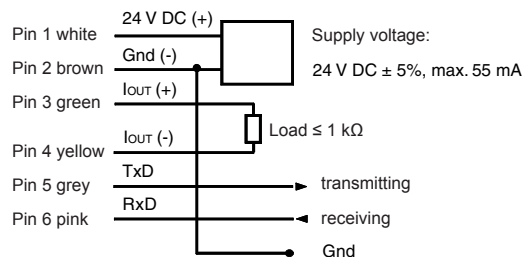

Technical Data			
<b>Supply voltage:</b>	24 V DC	<b>Operating temperature:</b>	0 °C bis +55 °C
<b>Input current:</b>	max. 55 mA	<b>Ingress protection:</b>	IP 65 (DIN 40050)
<b>direct Analog output:</b>	4... 20 mA	<b>Accuracy:</b>	± 1 % of actual value
<b>direct Digital output:</b>	RS 232	<b>Repeatability:</b>	0,2 % (over entire Range)
<b>Connection:</b>	6-pin plug	<b>Material:</b>	Thermoplastics

The analog inputs of instruments, which are connected to the analog output of the KME-16/35, must not be on operating voltage potential. Only instruments with galvanic isolated inputs must be used.

The max. cable length (w/o amplifier) is 2 m when using the RS 232 - interface and 20 m with the analog output.

An EPROM, inside the KME-16/35, is burnt for each individual application, therefore all medium specific data, which are necessary for special scaling, must be supplied with the order (concentration, viscosity, density).



# Flow Monitor

## RVP/U

### Operation

The flow monitors type RVP/U operate with the float measuring principle

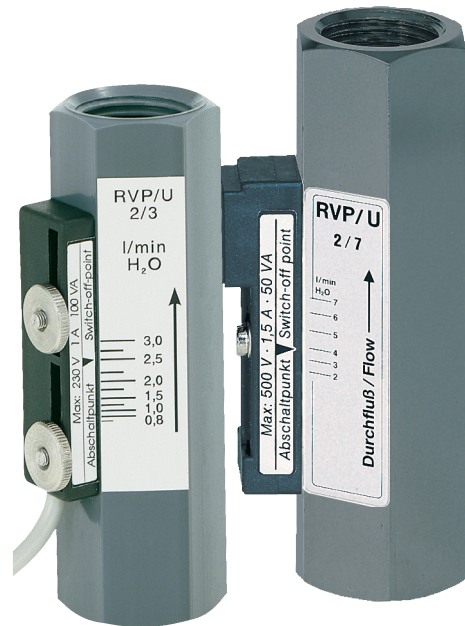

### Application

The flow monitors type RVP/U are used for monitoring volumeflow of liquid media.

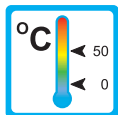

Areas of application:



– Coolingsystems and cooling-circuits

– Mechanical Engineering  
e.g. Weldingmachinery,  
Laserplants



– Medicine technology

– Research and development

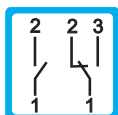

### Features

The RVP/U series proves itself through reliable function and easy handling. Further characteristics of this type are:

- universal mounting
- infinitely variable switchpoint adjustment through user
- suitable for distilled or demineralized water
- Threaded connection  
Special threads on request

### Installation hints

The installation of the flow monitor can be done in any way in the system. The flow direction must be observed.

The flow monitor must not be used as a supporting part in a pipeconstruction!

The medium must not contain any solid particles!  
We recommend the installation of strainers type SFD or SFM.

External magnetic fields influence the switch contact. Keep adequate distance to those magnetic fields (e.g. electromotors)!

The operating instruction for RVP/U must be observed under any circumstances!



# Measuring Ranges, Technical Data

## Connection diagram

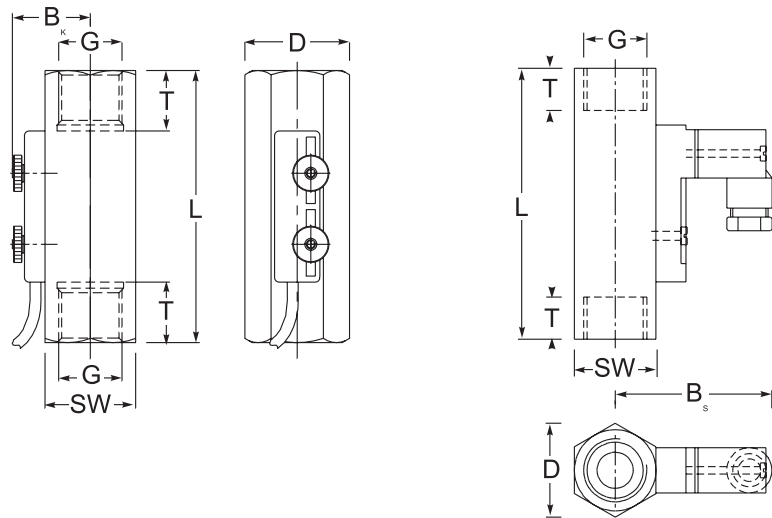
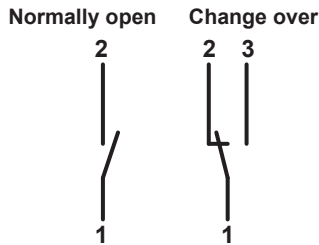

## Summary of types RVP/U

Type	Switch range* l/min H <sub>2</sub> O	Overall dimensions mm							Weight approx. [g]
		SW	D	B <sub>s</sub>	B <sub>k</sub>	G	T	L	
RVP/U-2/02	0,02 - 0,2	30	34	52	25,8	1/2"	13	90	150
RVP/U-2/06	0,1 - 0,6								
RVP/U-2/1	0,4 - 1,8								
RVP/U-2/3	0,8 - 3,2								
RVP/U-2/7	2 - 7								
RVP/U-2/13	3 - 13								
RVP/U-2/20	4 - 20								
RVP/U-2/30	8 - 30								

\* Other switch ranges on request

Operating data		RVP/U-2
Operating pressure:		PN 10 bar
Pressure drop:		0,02 - 0,3 bar
Maximum temperature:		50 °C
Accuracy:		10% of full scale
Electrical data:		
Normally open:		max. 230V • 3A • 60VA
Change over:		max. 250V • 1,5A • 50VA
Protection type:		IP65 (plug connection DIN 43650 Form C) IP67 (1m sealed in cable)
Output signal:		The contact opens / changes, when the flow falls below the set point.
Power supply:		Not required (potentialfree reed contact)
Other plug types or cable lengths on request		
Material:		
Housing:	(wetted part)	PVC-U (Hard-PVC)
Float:	(wetted part)	1.4571
Magnets:	(wetted part)	Hardferrit
Spring:	(wetted part)	1.4571
Stop rings:	(wetted part)	1.4571

RVP/U 2 0002 09-04 E M





Flow sensors and flow indicators with impeller or turbine

Types: **DHGF-2/DHGF-4**, **DHGF-10**, **DHGF-30/DHGF-50**,  
**DHSF-2/DHSF-4**, **DIGA-2/DIGA-4**, **DIGA-10**, **DHTF/DHTA**,  
**DOSF/L / DOGF/L**, **FRA**

**DHGF-2 / DHGF-4**



**Impeller flowmeter for liquids**

- high accuracy
- frequency output
- installation in any orientation
- thread connection

**DHGF-10**



**Impeller flowmeter for liquids**

- high accuracy
- frequency output
- installation in any orientation
- thread connection

**DHGF-30 / DHGF-50**



**Impeller flowmeter for liquids**

- high accuracy
- sturdy brass version
- optional chemical nickel plated

**DHSF-2 / DHSF-4**



**Impeller flowmeter for liquids**

- high accuracy
- frequency output
- installation in any orientation
- hose connection

**DIGA-2 / DIGA-4**

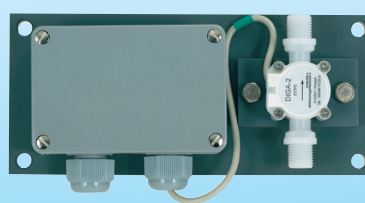

**Impeller flowmeter for liquids**

- high accuracy
- high chemical resistance
- Output 4 - 20 mA
- thread connection

**DIGA-10**



**Impeller flowmeter for liquids**

- high accuracy
- high chemical resistance
- Output 4 - 20 mA
- thread connection

**DHTF / DHTA**



**Impeller flowmeter for liquids**

- high accuracy
- choice between frequency or analog output
- installation via T-piece or threaded pipe adapter (not scope of supply)

**DOSF/L / DOGF/L**



**Impeller flowmeter for air**

- high accuracy
- frequency output
- installation in any orientation
- hose or thread connection

**FRA**



**Flow indicator for liquids**

- sturdy construction
- high reliability
- wiper for glass cleaning

## Flow sensors and flow indicators with impeller or turbine

Type: **FAA**

# 6

**FAA**



**Flow indicator**

- sturdy construction
- high reliability

# Impeller Flowmeter DHGF-2 and DHGF-4



## Method of operation

The flowmeters utilize impellers fitted with permanent magnets. Liquids flowing through the units will cause the impeller to rotate. The speed at which the impeller rotates is, over a wide range, proportional to the amount of liquid passing through the unit, which allows accurate determination of the flow rate. The impeller rpm is detected by means of a Hall-Sensor.

## Range of application

Measuring and monitoring of liquids within a viscosity range of 1 – 10 cST.

### Applicability

- constructional engineering
- laboratories
- chemical industry

## Measuring range

DHGF- 2: 1,5 – 200 l/h  
DHGF- 4: 6 – 400 l/h

## Special features

- high degree of reliability
- highly accurate
- high chemical resistance (ECTFE model)

## Mounting position

The units function in any mounting position and allow maximum flexibility in system integration. Optimum de-aeration is achieved when the units are mounted vertically. Ensure correct direction of flow at installation.

## Maintenance requirements

The flowmeters are low maintenance. However, the system should be purged and cleaned of impurities at regular intervals. This is especially important, should metal particles contaminate the system, as they will adhere to the permanent magnets on the impeller and may cause inaccurate readings and irreparable damage.

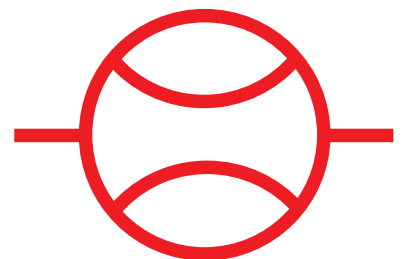

## Dimension Outline Drawing DHGF- 2 und DHGF- 4

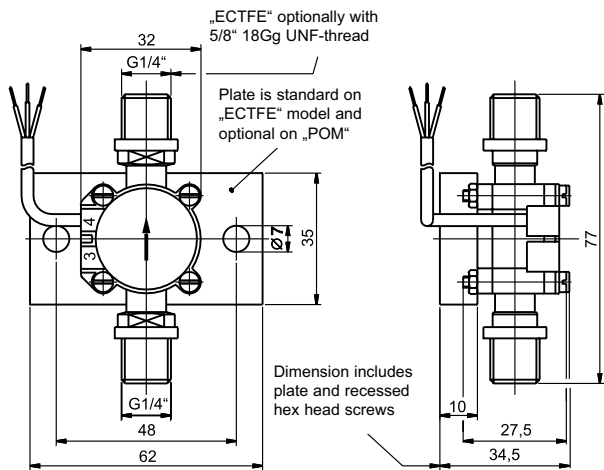

## Wiring diagram for POM version

Operating voltage 4,5 – 24 VDC

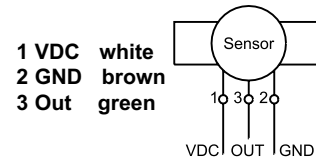

## Wiring diagram for ECTFE version

Operating voltage 10 – 24 VDC

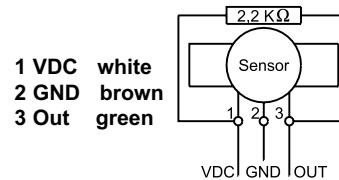

Operating data:	DHGF - 2 POM	DHGF - 4 POM	DHGF - 2 ECTFE	DHGF - 4 ECTFE
Range:	1,5 - 100 l/h	6 - 250 l/h	1,5 - 100 l/h	6 - 250 l/h
Viscosity range:	1 - 10 cSt			
Accuracy of measurement:	± 2% of rate			
Repeatability:	± 0,8% of rate			
Max. operating pressure:	10 bar			
Bursting pressure (at 22°C):	15 bar			
Operating temperature:	-10 bis +80°C			
Protection class:	IP65			
Signal output:	square wave (push-pull output stage)		square wave (open collector)	
Max. current output (at 24V):	11 mA			
Voltage requirement:	4,5 - 24 VDC		10 - 24 VDC	
Connecting cable (1m):	3 x 0,14 mm <sup>2</sup> LIYY			
Sensor housing:	POM		ECTFE	
Impeller:	POM		ECTFE	
Axle and bearing:	COREPOINT / POM	COREPOINT / ruby	sapphire / ruby	
Magnets:	sinter/ceramics		sinter/ceramics - encapsulated	
O-Rings (option):	FKM / EPDM		FKM / EPDM *	
Weight:	approx. 50 g			
Connection:	G 1/4"		G 1/4" or. 5/8" UNF	

\* optional KALREZ

### Pressure drop diagram

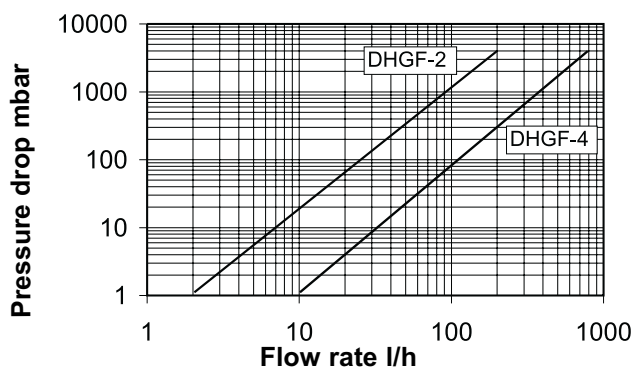

### Pulse characteristics curve

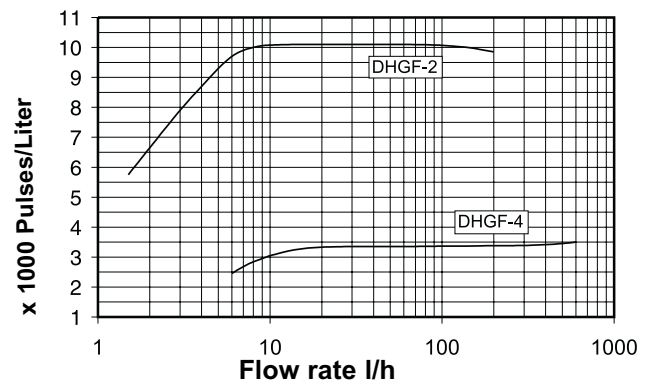

Valid are the general terms and conditions of Meister Strömungstechnik GmbH • Errors and technical changes excepted

# Impeller Flowmeter DHGF-10



## Method of operation

The flowmeter utilizes an impeller fitted with permanent magnets. Liquids flowing through the unit will cause the impeller to rotate. The speed at which the impeller rotates is, over a wide range, proportional to the amount of liquid passing through the unit, which allows accurate determination of the flow rate. The impeller rpm is detected by means of a Hall-Sensor.

## Range of application

Measuring and monitoring of liquids within a viscosity range of 1 – 10 cSt.

### Applicability:

- constructional engineering
- laboratories
- chemical industry

## Measuring range

DHGF- 10: 30 – 1000 l/h

## Special features

- high degree of reliability
- highly accurate
- threaded connection
- high chemical resistance (ECTFE model)

## Mounting position

The units function in any mounting position and allows maximum flexibility in system integration. Optimum de-aeration is achieved when the unit is mounted vertically. Ensure correct direction of flow at installation.

## Maintenance requirements

The flowmeter requires low maintenance. However, the system should be purged and cleaned of impurities at regular intervals. This is especially important, should metal particles contaminate the system, as they will adhere to the permanent magnets on the impeller and may cause inaccurate readings and irreparable damage.

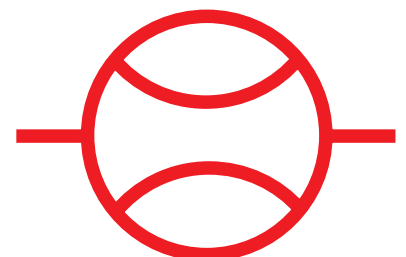

## Dimension Outline Drawing DHGF - 10

## Wiring diagram

Operating voltage 4,5 – 24 VDC

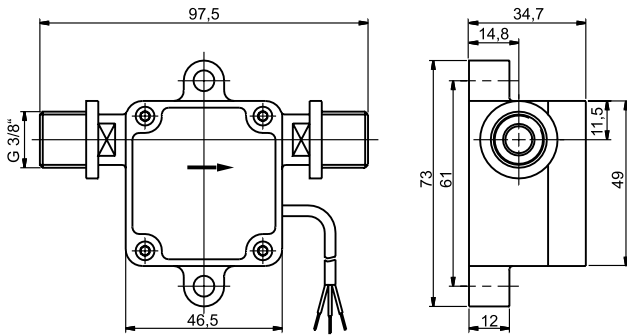

1 VDC white  
2 GND brown  
3 Out green

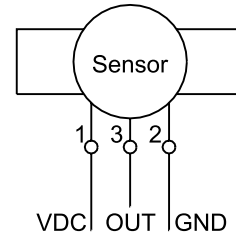

Operating data:	DHGF - 10 POM	DHGF - 10 ECTFE
Range:	30 - 1000 l/h	
Viscosity range:	1 - 10 cSt	
Accuracy of measurement:	± 2% of rate	
Repeatability:	± 0,8% of rate	
Max. operating pressure:	5 bar	
Bursting pressure (at 22°C):	8 bar	
Operating temperature:	-10 to +80°C *	
Protection class:	IP65	
Signal output:	square wave (push-pull output stage)	
Max. current output (at 24V):	11 mA	
Voltage requirement:	4,5 - 24VDC	
Connecting cable (1m):	3 x 0,14 mm <sup>2</sup> LIYY	
Sensor housing:	POM	ECTFE
Impeller:	POM	ECTFE
Axle and bearing:	NIVAPOINT / POM	ceramics / ceramics
Magnets:	sinter/ceramics-encapsulated	sinter/ceramics-encapsulated
O-Rings:	FKM / EPDM	
Weight:	approx. 80 g	
Connections:	G 3/8"	

\* Specials up to 100°C on request

Pressure drop diagram

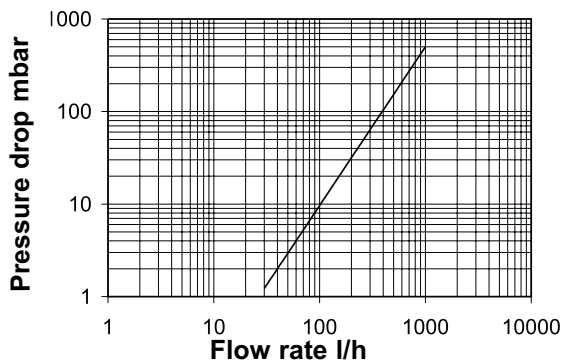

Pulse characteristics curve

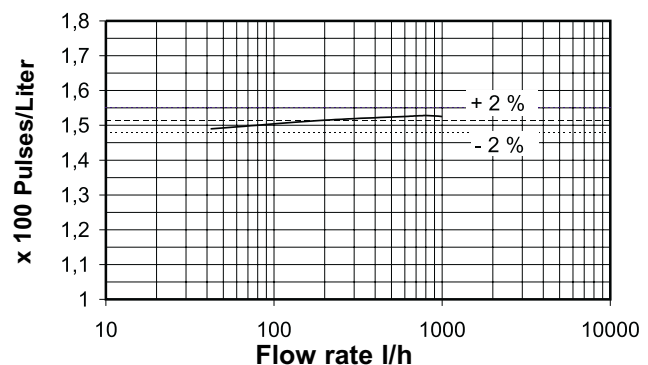

Valid are the general terms and conditions of Meister Strömungstechnik GmbH • Errors and technical changes excepted



# Impeller Flowmeter DHGF-30 & DHGF-50



## Method of operation

The flowmeters utilize impellers fitted with permanent magnets. Liquids flowing through the units will cause the impeller to rotate. The speed at which the impeller rotates is, over a wide range, proportional to the amount of liquid passing through the unit, which allows accurate determination of the flow rate. The impeller rpm is detected by means of a Hall-Sensor.

## Range of application

Measuring and monitoring of liquids within a viscosity range of 1 – 10 cSt.

### Applicability

- constructional engineering
- laboratories
- chemical industry

## Measuring range

DHGF- 30: 30 – 3000 l/h  
DHGF- 50: 50 – 5000 l/h

## Special features

- high degree of reliability
- highly accurate
- threaded connection
- solid brass construction
- chemically nickel plated (optional)

## Mounting position

The unit must be installed horizontally (plug facing up). Ensure correct direction of flow at installation.

## Maintenance requirements

The flowmeters require low maintenance. However, the system should be purged and cleaned of impurities at regular intervals. This is especially important, should metal particles contaminate the system, as they will adhere to the permanent magnets on the impeller and may cause inaccurate readings and irreparable damage.

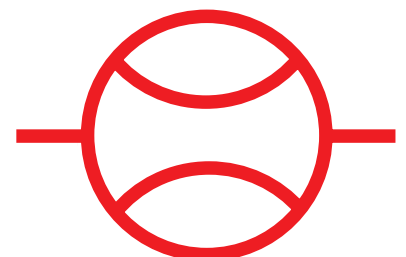



## Dimension Outline Drawing DHGF-30 and DHGF-50

## Wiring diagram

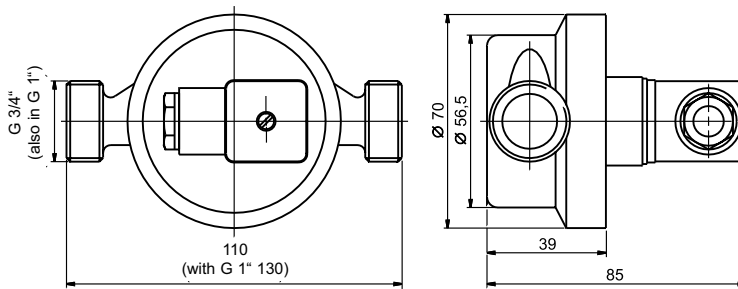

1 = Signal  
 2 = + 4,5 - 24 VDC  
 3 = GND  
 ⊕ = N. C. (Nicht belegt)

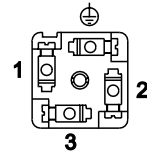

Operating data:	DHGF - 30	DHGF - 50
Range:	30 - 3000 l/h	50 - 5000 l/h
Viscosity range:	1 - 10 cSt	
Accuracy of measurement:	± 3% of rate	
Repeatability:	± 0,8% of rate	
Max. operating pressure:	10 bar	
Bursting pressure (at 22°C):	16 bar	
Operating temperature:	0 to +90°C	
Protection class:	plug in: IP 54	
Signal output:	square wave	
Pulse frequency:	38,785 pulses /l	22,783 pulses/l
Max. current output (at 24V):	11 mA *	
Voltage requirement:	4,5 - 24 VDC	
Socket:	DIN 43650	
Sensor housing:	brass nickel plated, optional chemically nickel plated	
Impeller:	Polyoxymethylen	
Axle and bearing:	nickel alloy / glass (point bearing with centering ring)	
Magnets:	sinter / ceramics	
O-Rings:	NBR	
Weight:	approx. 600 g	
Connections:	G 3/4"	G 1"

\*at temperatures < 60°C: 15mA

Pressure drop diagram

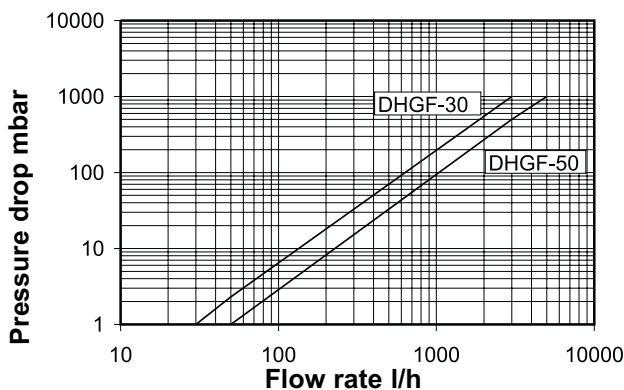

Pulse characteristics curve

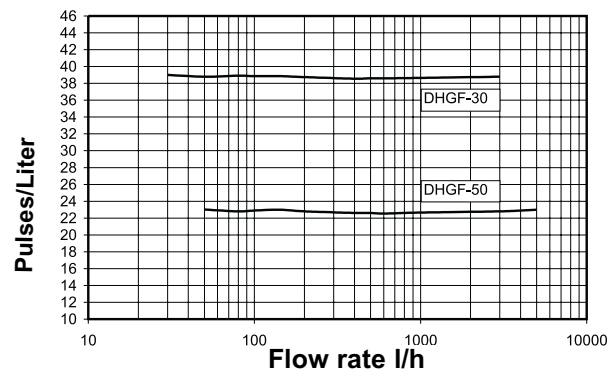

Valid are the general terms and conditions of Meister Strömungstechnik GmbH • Errors and technical changes excepted

# Impeller Flowmeter DHSF-2 and DHSF-4



## Method of operation

The flowmeters utilize impellers fitted with permanent magnets. Liquids flowing through the units will cause the impeller to rotate. The speed at which the impeller rotates is, over a wide range, proportional to the amount of Liquid passing through the unit, which allows accurate determination of the flow rate.

The impeller rpm is detected by means of a Hall-Sensor.

## Range of application

Measuring and monitoring of liquids within a viscosity range of 1 – 10 cSt.

Applicability:

- constructional engineering
- laboratories
- chemical industry

## Measuring range

DHSF- 2: 1,5 – 200 l/h

DHSF- 4: 6 – 400 l/h

## Special features

- high degree of reliability
- highly accurate
- hose connection

## Mounting position

The units function in any mounting position and allow maximum flexibility in system integration. Optimum de-aeration is achieved when the units are mounted vertically.

Ensure correct direction of flow at installation.

## Maintenance requirements

The flowmeters require low maintenance. However, the system should be purged and cleaned of impurities at regular intervals. This is especially important, should metal particles contaminate the system, as they will adhere to the permanent magnets on the impeller and may cause inaccurate readings and irreparable damage.

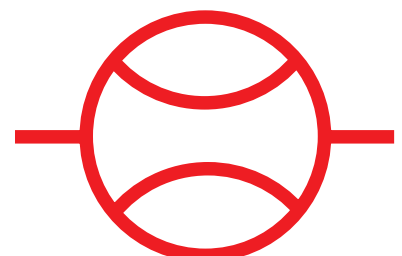

## Dimension Outline Drawing DHSF-2 und DHSF-4

## Wiring diagram

Operating voltage 4,5 – 24 VDC

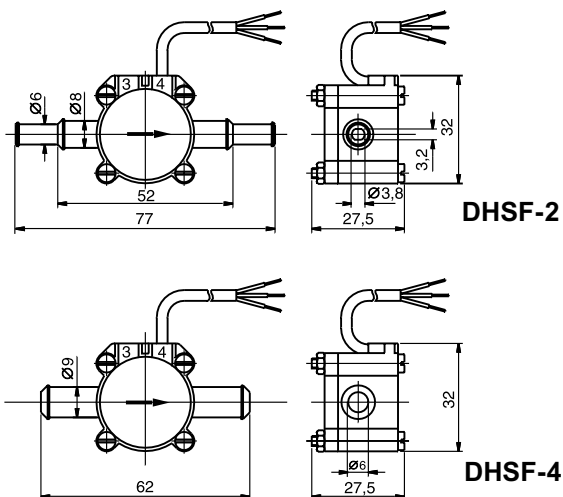

1 VDC white  
2 GND brown  
3 Out green

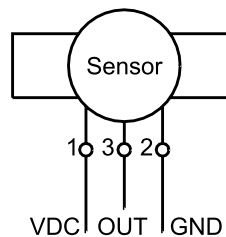

Operating data:	DHSF - 2 POM	DHSF - 4 POM
Range:	1,5 - 100 l/h	6 - 250 l/h
Viscosity range:	1 - 10 cSt	1 - 10 cSt
Accuracy of measurement:	± 2% of rate	
Repeatability:	± 0,8% of rate	
Max. operating pressure:	10 bar	
Bursting pressure (at 22°C):	15 bar	
Operating temperature:	- 10 bis + 80°C	
Protection class:	IP65	
Signal output:	square wave (push-pull output stage)	
Max. current output (at 24V):	11 mA	
Voltage requirement:	4,5 - 24VDC	
Connecting cable (1m):	3 x 0,14 mm <sup>2</sup> LIYY	
Sensor housing:	POM	
Impeller:	POM	
Axle and bearing:	NIVAPPOINT / POM	NIVAPPOINT / ruby
Magnets:	sinter / ceramics	
O-Rings:	FKM / EPDM	FKM / EPDM
Weight:	approx. 45 g	
Hose connection:	6 / 8 mm	9 mm

Pressure drop diagram

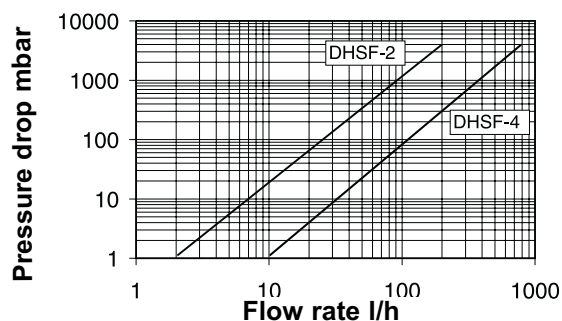

Pulse characteristics curve

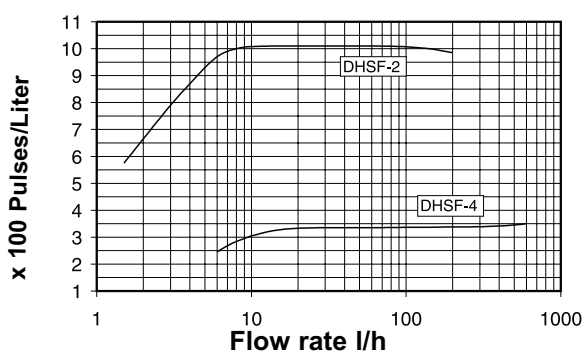

Valid are the general terms and conditions of Meister Strömungstechnik GmbH • Errors and technical changes excepted



# Impeller Flowmeter DIGA-2 and DIGA-4

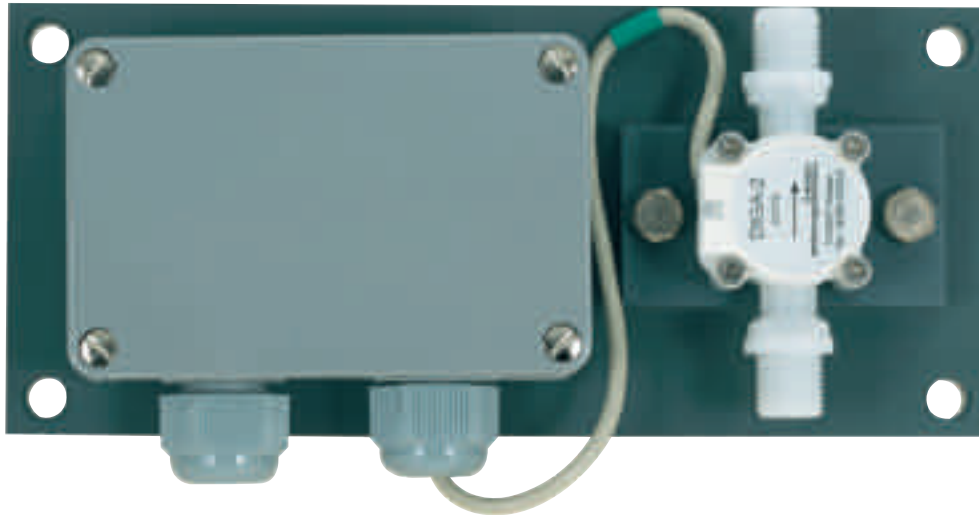

## Method of operation

These flowmeters utilize impellers fitted with permanent magnets. Liquids flowing through the units will cause the impeller to rotate. The speed at which the impeller rotates is, over a wide range, proportional to the amount of liquid passing through the unit, which allows accurate determination of the flow rate.

The impeller rpm is sensed inductively.

A 4 – 20 mA electric current is generated by means of attached electronics.

## Range of application

Measuring and monitoring of liquids within a viscosity range of 1 – 10 cSt.

Applicability:

- constructional engineering
- laboratories
- chemical industry

## Measuring range

DIGA- 2: 1,5 – 200 l/h

DIGA- 4: 6 – 400 l/h

## Special features

- high degree of reliability
- highly accurate
- high chemical resistance
- signal output 4 – 20 mA

## Mounting position

The units function in any mounting position and allow maximum flexibility in system integration.

Optimum de-aeration is achieved when the units are mounted vertically.

Ensure correct direction of flow at installation.

## Maintenance requirements

The flowmeters require low maintenance. However, the system should be purged and cleaned of impurities at regular intervals. This is especially important should metal particles contaminate the system, as they will adhere to the permanent magnets on the impeller and may cause inaccurate readings and irreparable damage.

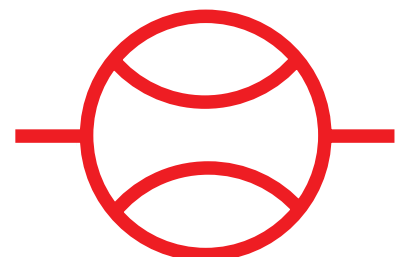

## Installation diagram for DIGA - 2 and DIGA - 4

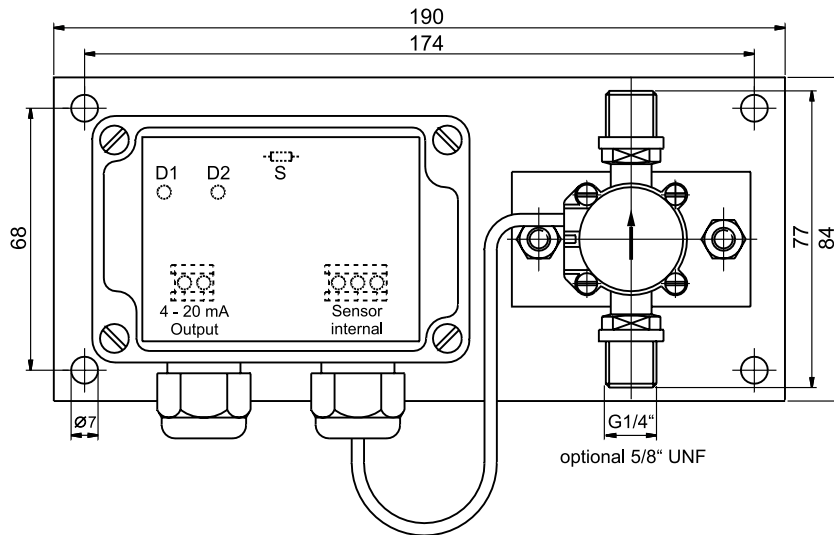

Operating data:	DIGA - 2 ECTFE	DIGA - 4 ECTFE
Range:	1,5 - 100 l/h	6 - 250 l/h
Viscosity range:	1-10 cSt	
Accuracy of measurement:	± 2% of rate	
Repeatability:	± 0,8% of rate	
Max. operating pressure:	10 bar	
Bursting pressure (at 22°C):	15 bar	
Operating temperature:	- 10°C to + 80°C	
Protection class:	IP 65	
Signal output:	4 - 20 mA dependent on flowrate. The limiting values for 4 and 20 mA are adjustable by means of a magnetic pointer.	
Voltage requirement:	10 - 30 VDC arranged in series in the 4 - 20 mA measuring circuit. Current consumption < 4 mA at 100% duration of voltage application.	
Electrical connection:	selectable	
Sensor housing:	ECTFE	
Impeller:	ECTFE	
Axle and bearing:	sapphire / sapphire	
Magnets:	ECTFE-encapsulated	
O-Rings (selective):	FKM / EPDM *	
Weight:	approx. 350 g	
Connections (selective):	G 1/4" / 5/8" UNF	

\* optional KALREZ

Valid are the general terms and conditions of Meister Strömungstechnik GmbH • Errors and technical changes excepted

# Impeller Flowmeter DIGA-10



## Method of operation

This flowmeter utilizes an impeller fitted with permanent magnets. Liquids flowing through the unit will cause the impeller to rotate. The speed at which the impeller rotates is, over a wide range, proportional to the amount of liquid passing through the unit, which allows accurate determination of the flow rate. The impeller rpm is sensed inductively.

Flowmeters of Type DIGA-10 generate a 4 – 20 mA electric current by means of integrated electronics.

## Range of application

Measuring and monitoring of liquids within a viscosity range of 1 – 10 cSt.

Applicability:

- constructional engineering
- laboratories
- chemical industry

## Measuring range

DIGA-10: 30 – 1000 l/h

## Special features

- high degree of reliability
- highly accurate
- high chemical resistance
- signal output 4 – 20 mA

## Mounting position

The units function in any mounting position and allows maximum flexibility in system integration. Optimum de-aeration is achieved when the unit is mounted vertically. Ensure correct direction of flow at installation.

## Maintenance requirements

The flowmeter requires low maintenance. However, the system should be purged and cleaned of impurities at regular intervals. This is especially important should metal particles contaminate the system, as they will adhere to the permanent magnets on the impeller and may cause inaccurate readings and irreparable damage.

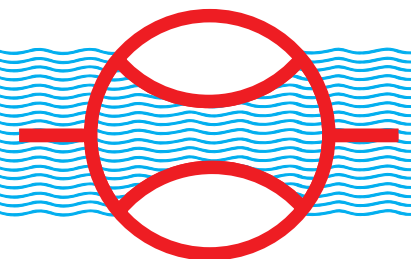

## Installation diagram for DIGA - 10

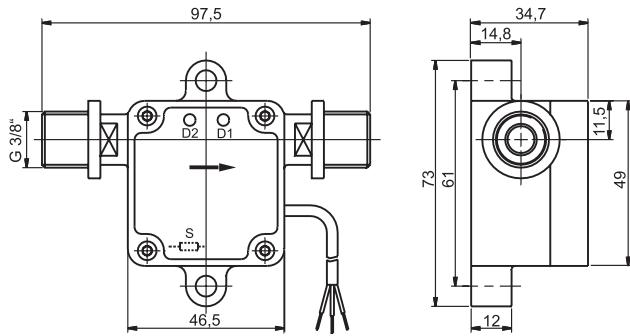

## Wiring diagram

1 VDC white  
2 GND brown  
3 OUT green

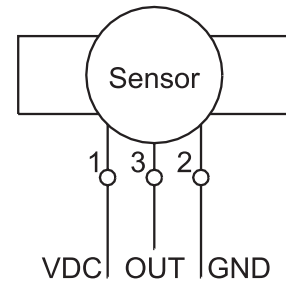

Operating data:	DIGA - 10 ECTFE
Range:	30 – 1000 l/h
Viscosity range:	1 – 10 cSt
Accuracy of measurement:	±2 % of rate
Repeatability:	±0,8 % of rate
Max. operating pressure:	5 bar
Bursting pressure (at 22 °C):	8 bar
Operating temperature:	-10 °C to +55 °C *
Protection class:	IP 65
Signal output:	4 – 20 mA dependent on flowrate The limiting values for 4 and 20 mA are adjustable by means of a magnetic pointer.
Voltage requirement:	12 – 24 VDC arranged in series in the 4 – 20 mA measuring circuit current consumption < 4 mA at 100 % duration of voltage application
Electrical connection:	selectable
Sensor housing:	ECTFE
Impeller:	ECTFE
Axle and bearing:	sapphire / sapphire                      ceramics / ceramics **
Magnets:	ECTFE-encapsulated
O-Rings (selective):	FKM / EPDM ***
Weight:	approx. 80 g
Connections:	G 3/8"

\* Special design up to 100 °C upon request; \*\* at flowrate > 500 l/h; \*\*\* optional KALREZ

### Pressure drop diagram

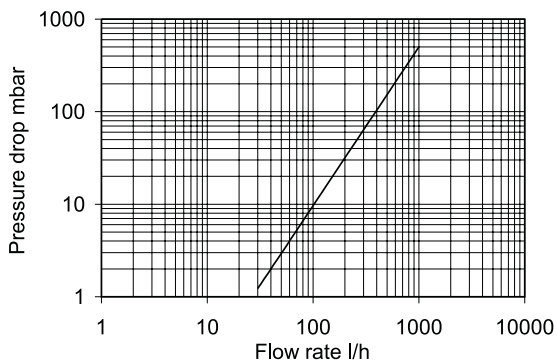

### Pulse characteristics curve

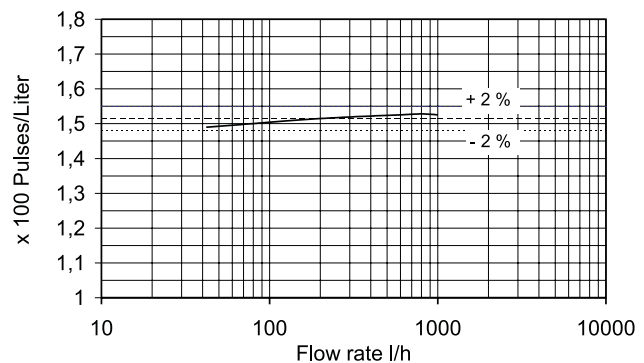

technical changes and amendments reserved

Valid are the general terms and conditions of Meister Strömungstechnik GmbH • Errors and technical changes excepted





# Impeller Flowmeter DHTF and DHTA



## Method of operation

The flowmeters, type DHTF and DHTA utilize a paddle rotor fitted with permanent magnets. Liquids flowing through the units will cause the rotor to spin. The speed of rotation is, over a wide range, proportional to the velocity of liquid passing through the unit. The rotor rpm is detected by means of a Hall-Sensor. Flowmeters of type DHTA generate a 4 – 20 mA current by means of integrated electronics.

## Range of application

Measuring and monitoring of liquids within a viscosity range of 0,5 – 20 cSt.

### Applicability:

- constructional engineering
- laboratories
- chemical industry

## Measuring range

DHTF and DHTA  
0,15 – 10 m/s

## Special features

- high degree of reliability
- highly accurate
- installation in various pipe diameters possible (installation by means of a T-adaptor or socket)

## Mounting position

The units function in any mounting position and allow maximum flexibility in system integration. Optimum de-aeration is achieved when the units are mounted vertically. If mounted horizontally, the sensor must be positioned to preclude accumulation of sediment and other impurities around the sensor. Ensure correct direction of flow at installation.

## Maintenance requirements

The flowmeters require low maintenance. However, the system should be purged and cleaned of impurities at regular intervals. This is especially important, should metal particles contaminate the system, as they will adhere to the permanent magnets on the paddle rotor and may cause inaccurate readings and irreparable damage.

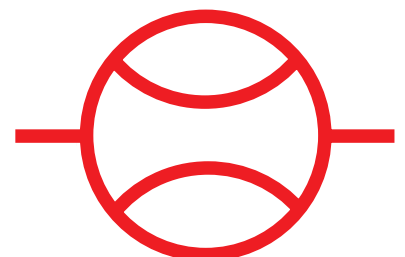

## Installation diagram for DHTF and DHTA

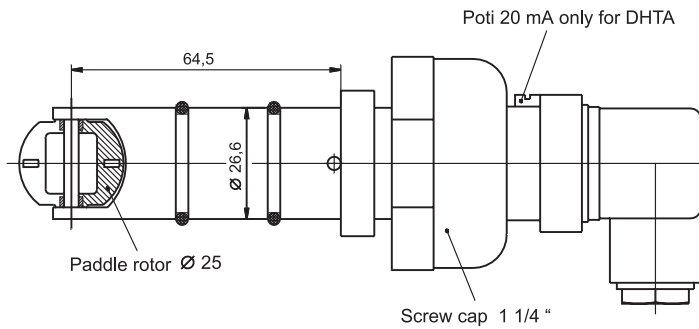

## Wiring diagram DHTF

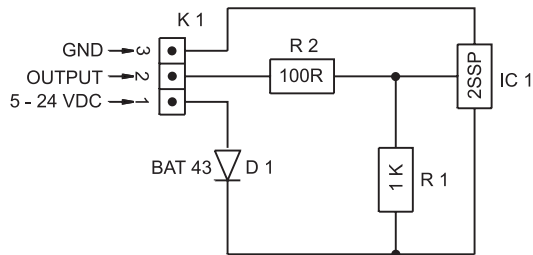

## Wiring diagram DHTA

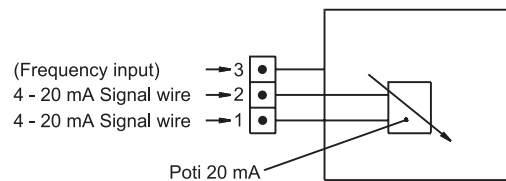

Operating data:	DHTF	DHTA
Range:	0,15 – 10 m/s	0,15 – 10 m/s
Viscosity range:	0,5 – 20 cSt	0,5 – 20 cSt
Accuracy of measurement:	±1 % of rate over calibrated range	±2 % of rate over calibrated range
Repeatability:	±0,5 % of rate	±0,8 % of rate
Max. operating pressure:	10 bar	10 bar
Bursting pressure (at 22 °C):	15 bar	15 bar
Operating temperature:	-10 to +85 °C	-10 to +85 °C
Protection class:	IP 65	IP 65
Signal output:	true square wave pulse frequency approx. 42 Hz / $\frac{m}{s}$	4 – 20 mA (adjustable)
Max. current output (at 24 V):	11 mA *	----
Voltage requirement:	5 – 24 VDC	5 – 24 VDC (at 20 mA instrument leads arranged in series)
Power plug:	DIN 43650	DIN 43650
Electrical connections:	see wiring diagram	see wiring diagram
Sensor housing:	PP	PP
Paddle rotor:	ECTFE	ECTFE
Axle and bearing:	ceramics (A <sub>2</sub> O <sub>3</sub> ) / ceramics (A <sub>2</sub> O <sub>3</sub> )	ceramics (A <sub>2</sub> O <sub>3</sub> ) / ceramics (A <sub>2</sub> O <sub>3</sub> )
Magnets:	ECTFE-encapsulated	ECTFE-encapsulated
O-Rings:	Viton **	Viton **
Weight:	approx. 126 g	approx. 126 g
Connections:	by means of T-adaptor or socket (not in scope of supply)	

\* at temperatures < 60 °C: 15 mA; \*\* optional EPDM

technical changes and amendments reserved

**meister**  
**strömungstechnik**  
Im Gewerbegebiet 2 · D – 63831 Wiesen

Telefon : 0 60 96 / 97 20 - 0  
Telefax : 0 60 96 / 97 20 - 30  
E - Mail: Info@meister-flow.com  
Internet: http://www.meister-flow.com

# Impeller Flowmeter DOSF/L and DOGF/L



## Method of operation

The flowmeters utilize an impeller which is set into motion when a gas flows through the unit. The speed at which the impeller rotates is, over a wide range, proportional to the amount of gas passing through the unit, which allows accurate determination of the flow rate. The rotor rpm is sensed by optoelectrical means.

## Range of application

Measuring and monitoring of gas

Applicability:

- constructional engineering
- laboratories
- chemical industry

## Measuring range

DOSF/L- 30 and DOGF/L- 30  
1 – 30 l/min air  
DOSF/L-130 and DOGF/L-130  
20 – 130 l/min air

## Special features

- high degree of reliability
- highly accurate
- hose or threaded connections

## Mounting position

The units function in any mounting position and allows maximum flexibility in system integration. Ensure correct direction of flow at installation.

## Maintenance requirements

The flowmeters require low maintenance. However, the system should be purged and cleaned of impurities at regular intervals.

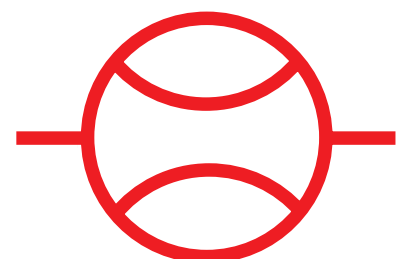

### Installation Diagram for DOSF/L-30 and DOSF/L-130

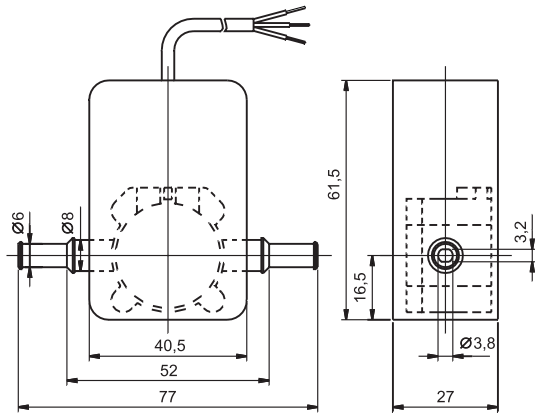

### Installation Diagram for DOGF/L-30 and DOGF/L-130

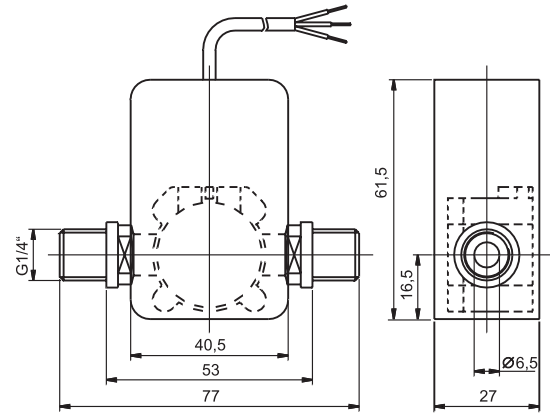

### Wiring diagram

Operating voltage 5 – 12 VDC

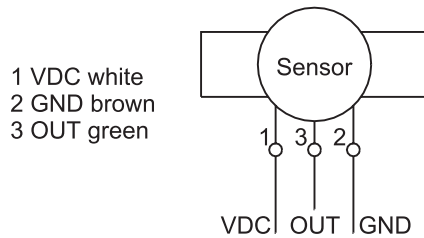

### Frequency characteristics

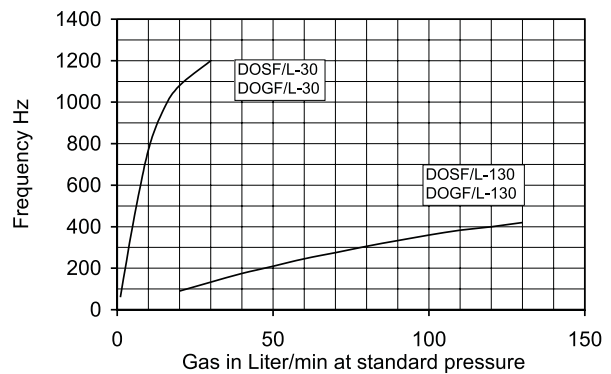

Operating Data:	DOSF/L-30	DOGF/L-30	DOSF/L-130	DOGF/L-130
Range:	1 – 30 l/min	1 – 30 l/min	20 – 130 l/min	20 – 130 l/min
Accuracy of measurement:	± 3 % of rate	± 3 % of rate	± 3 % of rate	± 3 % of rate
Repeatability:	± 0,8 % of rate	± 0,8 % of rate	± 0,8 % of rate	± 0,8 % of rate
Max. operating pressure:	10 bar	10 bar	10 bar	10 bar
Bursting pressure ( at 22°C):	15 bar	15 bar	15 bar	15 bar
Operating temperature:	-10 to +40 °C *	-10 to +40 °C *	-10 to +40 °C *	-10 to +40 °C *
Protection class:	IP 54	IP 54	IP 54	IP 54
Signal output:	square wave	square wave	square wave	square wave
Max. current output (at 12 V):	2,5 mA	2,5 mA	2,5 mA	2,5 mA
Voltage requirement:	5 – 12 VDC	5 – 12 VDC	5 – 12 VDC	5 – 12 VDC
Connetcing cable (1m):	3 x 0,14 mm <sup>2</sup> LIYY	3 x 0,14 mm <sup>2</sup> LIYY	3 x 0,14 mm <sup>2</sup> LIYY	3 x 0,14 mm <sup>2</sup> LIYY
Electrical connections:	see wiring diagram			
Outer housing:	ABS	ABS	ABS	ABS
Sensor housing:	POM	POM	POM	POM
Impeller:	POM	POM	POM	POM
Axle and bearing:	NIVAPOINT / POM	NIVAPOINT / POM	NIVAPOINT / POM	NIVAPOINT / POM
O-Rings (selective):	FKM / EPDM	FKM / EPDM	FKM / EPDM	FKM / EPDM
Weight:	approx. 42 g	approx. 42 g	approx. 42 g	approx. 42 g
Connections:	6/8 mm	G 1/4"	6/8 mm	G 1/4"

\* Special design up to + 70 °C upon request

technical changes and amendments reserved

**meister**  
**strömungstechnik**  
Im Gewerbegebiet 2 · D – 63831 Wiesen

Telefon : 0 60 96 / 97 20 - 0  
Telefax : 0 60 96 / 97 20 - 30  
E - Mail: Info@meister-flow.com  
Internet: http://www.meister-flow.com

# Flow Indicator

## FRA

### Operation

The models FRA are impeller flow indicators



### Application

The flow indicators model FRA are used to indicate flow of liquid media.

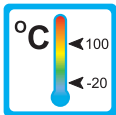

Areas of application :



– Coolingsystems and cooling-circuits

– Mechanical Engineering

– Watertreatment



– Pharma industry

– Research and development

### Features

The FRA series proves itself through reliable function and easy handling. Further characteristics of this sturdy type are:

- universal orientation
- high reliability
- threaded connection

### Installation hints

The installation of the flow indicator can be done in any way in the system. The flow direction must be observed. In case of very low flow we suggest a vertical mounting.

The flow indicator must not be used as a supporting part in a pipe construction!

The medium must not contain any solid particles! We recommend the installation of strainers type SFD or type SFM.



## Technical Data

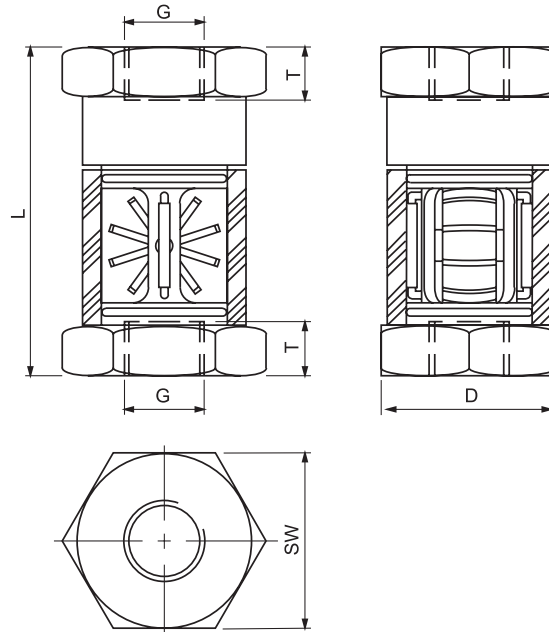

### Summary of types FRA

Type	Flowrate min. H <sub>2</sub> O [l/min]	Flowrate max. H <sub>2</sub> O [l/min]	Overall dimensions mm					Weight approx. [g]
			G	SW	D	T	L	
FRA-8	0,4	4	1/4"	36	30	12	71	300
FRA-10	0,6	8	3/8"	36	30	14	75	300
FRA-15	1,0	12	1/2"	46	40	14	86	600
FRA-20	1,0	25	3/4"	46	40	16	95	600
FRA-25	1,6	40	1"	46	40	18	105	600
FRA-32	7,5	80	1 1/4"	70	65	20	120	1500
FRA-40	8,0	100	1 1/2"	70	65	22	130	1600

Operating data	FRA	
Operating pressure max.:	PN 16 bar	
Operating temperature max.:	100 °C	
Pressure drop:	0,25 bar	
Material	Brass	Stainless Steel
Body:	Brass nickel-plated	1.4305
Rotor (DN 8 to DN 25):	POM red	POM red
Rotor (DN 32 to DN 40):	Nylon white	Nylon white
Wiper:	Polyolitin	Polyolitin
Gaskets:	Perbunan	Viton

FRA.2 0001 11-04 E.M



# Flow Indicator

## FAA

### Operation

The models FAA are impeller-flow indicators



### Application

The flow indicators model FAA are used to indicate flow of liquid media.

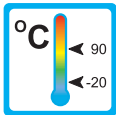

Areas of application for example:



– Coolingsystems and cooling-circuits

– Mechanical Engineering



– Watertreatment

– Pharma industry

– Research and development

### Features

The FAA series proves itself through reliable function and easy handling. Further characteristics of this sturdy type are:

- universal mounting
- high reliability
- threaded connection

### Installation hints

The installation of the flow indicator can be done in any way in the system. The flow direction must be observed. In case of very low flow we suggest a vertical mounting.

The flow indicator must not be used as a supporting part in a pipeconstruction!

The medium must not contain any solid particles! We recommend the installation of strainer type SFD or SFM.





## Technical Data

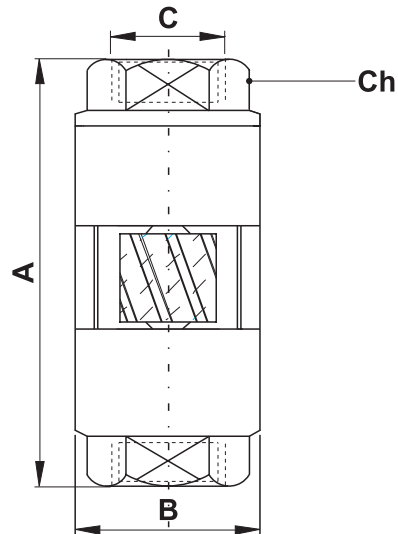

### Summary of types FAA

Type	Flowrate H <sub>2</sub> O [l/min]	A	B	C	Ch	Weight [g]	max. Press. [bar]	max. Temp. [°C]
FAA-8	1 - 10	59	25	1/4"	19	123	10	90
FAA-10	2 - 20	71	30	3/8"	24	190	8	90
FAA-15	3 - 30	71	30	1/2"	24	160	8	90
FAA-20	4 - 40	106	47	3/4"	40	675	5	90
FAA-25	6 - 60	106	47	1"	40	572	5	90

NPT-thread on request

<b>Material:</b>	Brass
Body:	Brass nickel-plated
Impeller:	Hostaform® red
Sight glass:	Pyrex®
Gaskets:	NBR

Stainless steel model (Aisi 304/316) on request

FAA 2 0002 02-05 E M

No products in this category

7

**CATEGORY UNDER CONSTRUCTION**

# Paddle flow monitors and baffle plate flowmeter

Types: **SPM**, **SPM-L**, **DP-65**

## SPM

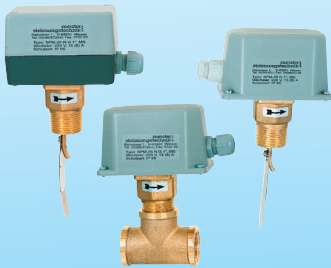

### Paddle flow monitor for liquids

- low sensitivity to dirt
- high switch rating
- suitable for open ducts

## SPM-L

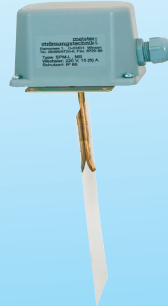

### Paddle flow monitor for air

- low sensitivity to dirt
- high switch rating

## DP-65

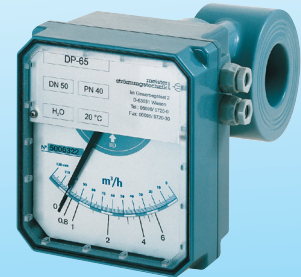

### Stauklappen-Durchflussmesser für flüssige Medien

- product specific scale
- low sensitivity to dirt
- wafer type (sandwich mounting)
- several options

## SPM

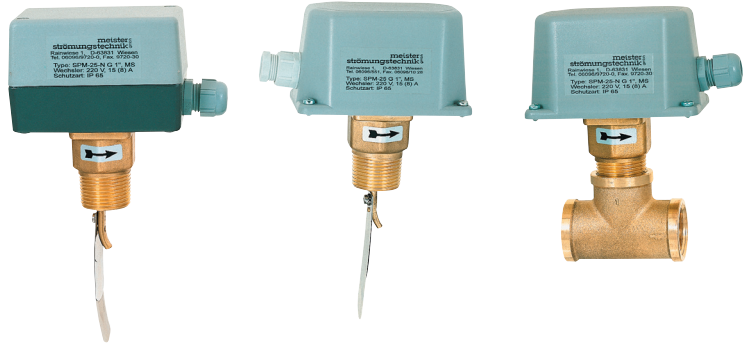

### Operation

The flow monitors type SPM are paddle switches

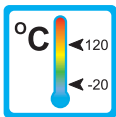

### Application

The flow monitors type SPM are used for monitoring volumeflow of liquid media in pipe constructions and open ducts.

Areas of application:

- Coolingsystems and cooling-circuits
- Heating and air-conditioning systems
- Research and development

### Features

The SPM series proves itself through reliable function and easy handling. A bellow separates the electrical and the wetted part of the SPM.

All instruments without a T-piece are supplied with four separate paddles, which can be combined.

The choice of the combination is determined by the pipe diameter (refer to table 3 on page 2).

If necessary the paddles have to be shortened according to pipe size.

Further characteristics of this sturdy type are:

- low sensitivity to dirt
- high contact rating
- easy installation
- low pressure drop

### Hints

The installation of the flow monitor can be done in any way in the system. The flow direction must be observed. Flow-straightening sections of at least 5x the pipe diameter should be considered up- and down-stream of the SPM. The switchpoint must be re-adjusted for vertical installation to compensate the paddle weight.

If the monitor is installed upside down, it must be observed that no deposits can clog the bellow!

The flow monitor must not be used as a supporting part in a pipe construction!



# Technical Data

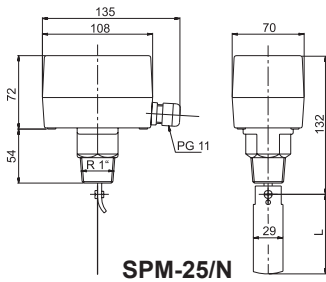

SPM-25/N

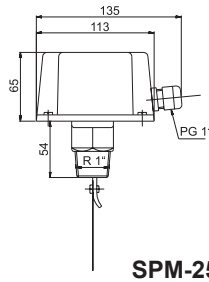

SPM-25

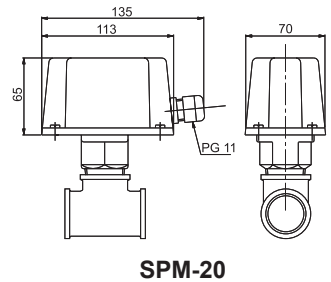

SPM-20

## Connection diagram

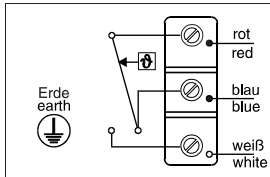

red: common

blue: N. C. (Normally closed)

white: N. O. (Normally open)

For switch values refer to table 3.

The instruments are factory adjusted for minimum switch values.

By turning the spanscrew clockwise the switch values can be increased (refer to operating instruction).

### Table 1: Overview

Type	Pipe size	p <sub>max</sub> [bar]	Material
SPM-15	1/2"	11	Brass
SPM-20	3/4"	11	Brass
SPM-25	1" - 8"	11	Brass
SPM-25 VA	1" - 8"	30	SS: 316L
SPM-25T*	1" - 8"	11	Brass
SPM-25/N	1" - 8"	11	Brass
SPM-25/N VA	1" - 8"	30	SS: 316L
SPM-25R	1" - 8"	11	Brass
SPM-25R VA	1" - 8"	30	SS: 316L
SPM-25R/N	1" - 8"	11	Brass
SPM-25R/N VA	1" - 8"	30	SS: 316L

\* SPM-25T is TÜV certified

### Table 2: Paddle lengths and paddle material

Paddle	Length L	Material
1	standard (as of DN 50): 28,5 mm	SS: 316
	with DN 25 the paddle must be cut to size	
2	standard: 54,5 mm	SS: 316
3	standard: 83,5 mm	SS: 316
4	standard (ab DN 175): 162,5 mm	SS: 316
	*Special length for DN 100: 92,0 mm	
	*Special length for DN 125: 117 mm	
	*Special length for DN 150: 143 mm	

\*By shorten the standard paddle, the user can obtain the special lengths

### Table 3: Switch values for H<sub>2</sub>O

Types: SPM-15 (with T-piece), SPM-20 (with T-piece)

Type	Connection	switch-off value [l/h]	switch-on value [l/h]
SPM-15	1/2"	174 - 846	480 - 948
SPM-20	3/4"	138 - 768	408 - 858

Types: SPM-25, SPM-25 VA, SPM-25T, SPM-25/N, SPM-25/N VA

DN	fitted paddle	switch-off value [m <sup>3</sup> /h]	switch-on value [m <sup>3</sup> /h]
25	1	0,6 - 2,0	1,0 - 2,1
32	1	0,8 - 2,8	1,3 - 3,0
40	1	1,1 - 3,7	1,7 - 4,0
50	1 2	2,2 - 5,7	3,1 - 6,1
65	1 2	2,7 - 6,5	4,0 - 7,0
80	1 2 3	4,3 - 10,7	6,2 - 11,4
100	1 2 3	11,4 - 27,7	14,7 - 29,0
100	1 2 3 4	6,1 - 17,3	8,0 - 18,4
125	1 2 3	22,9 - 53,3	28,4 - 55,6
125	1 2 3 4	9,3 - 25,2	12,9 - 26,8
150	1 2 3	35,9 - 81,7	43,1 - 85,1
150	1 2 3 4	12,3 - 30,6	16,8 - 32,7
200	1 2 3	72,6 - 165,7	85,1 - 172,5
200	1 2 3 4	38,6 - 90,8	46,5 - 94,2

Types: SPM-25R, SPM-25R VA, SPM-25R/N, SPM-25R/N VA

DN	fitted paddle	switch-off value [m <sup>3</sup> /h]	switch-on value [m <sup>3</sup> /h]
25	1	0,2 - 1,0	0,6 - 1,1
32	1	0,25 - 1,4	0,9 - 1,6
40	1	0,5 - 1,9	1,2 - 2,2
50	1 2	0,9 - 3,6	2,3 - 4,1
65	1 2	1,2 - 4,9	3,1 - 5,5
80	1 2 3	2,1 - 7,4	4,9 - 8,2
100	1 2 3	4,9 - 17,1	11,3 - 19,1
100	1 2 3 4	3,3 - 11,6	7,7 - 13,0
125	1 2 3	9,7 - 34,0	22,4 - 37,9
125	1 2 3 4	5,0 - 17,5	11,5 - 19,6
150	1 2 3	13,6 - 47,6	31,5 - 53,2
150	1 2 3 4	6,1 - 21,4	14,1 - 23,9
200	1 2 3	25,7 - 90,1	59,6 - 100,7
200	1 2 3 4	21,7 - 55,3	36,5 - 61,8

## Technical Data

Housing:	Galvanized steel bottom plate with ABS-Cover; Ingress protection: IP 65		
optional (SPM-.../N):	Painted aluminium bottom housing with ABS-Cover; Ingress Protection: IP 65		
Contact:	Dust tight micro switch	switch values:	15 (8) A, 24 - 250 V AC
optional:	Gold contacts on request		
Medium temperature:	-20 °C to 120 °C	Ambient temperature max.:	85 °C



## SPM-L



### Operation

The flow switches type SPM-L are paddle switches



### Application

The flow switches type SPM-L are used for monitoring volumeflow of gases.

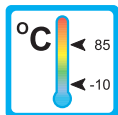

Areas of application:



– Coolingsystems and cooling-circuits

– Heating and air-conditioning systems



– Research and development

### Features

The SPM-L series proves itself through reliable function and easy handling.

Further characteristics of this sturdy type are:

- low sensitivity to dirt
- high contact rating
- easy installation
- low pressure drop

### Installation hints

The flow switch can be installed horizontally or vertically in the system. The instrument must not be installed upside down. The flow direction must be observed.

Flow-straightening sections of at least 5x the pipe diameter should be considered up- and down-stream of the SPM-L. The switchpoint must be re-adjusted for vertical installation to compensate the paddle weight.

The flow switch must not be used as a supporting part in a pipe construction!



# Technical Data

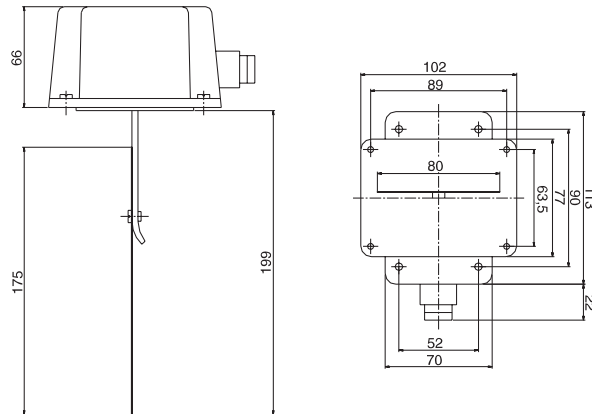

**SPM-L**

## Connection diagram

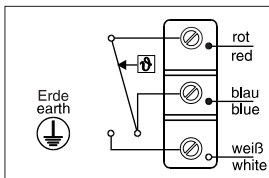

red: common

blue: N. C. (Normally closed)

white: N. O. (Normally open)

For switch values refer to table 1.

The instruments are factory adjusted for minimum switch values.

By turning the spancrew clockwise the switch values can be increased (refer to operating instruction).

**Table 1: Switch values for air**

Type	switch-off value min. [m/s]	switch-off value max. [m/s]	switch-on value min. [m/s]	switch-on value max. [m/s]
SPM-L	1,0	8,0	2,5	9,2

If the switchpoint is above 5 m/s the paddle has to be cut off at the marking.

Then the lowest switch-off value increases to 2,5 m/s flow velocity.

## Technical Data

Housing:	Galvanized steel bottom plate with ABS-Cover; Ingress protection of the external side: IP 65			
Mounting plate:	Brass			
Paddle:	Stainless Steel 1.4310			
Contact:	Dust tight micro switch	Switch values:	15 (8) A, 24 - 250 V AC	
optional:	Gold contacts on request			
Medium temperature:	-10 °C to 85 °C	Ambient temperature:	-10 °C to 85 °C	

SPM-L 2 0002 02-05 E M





## DP-65

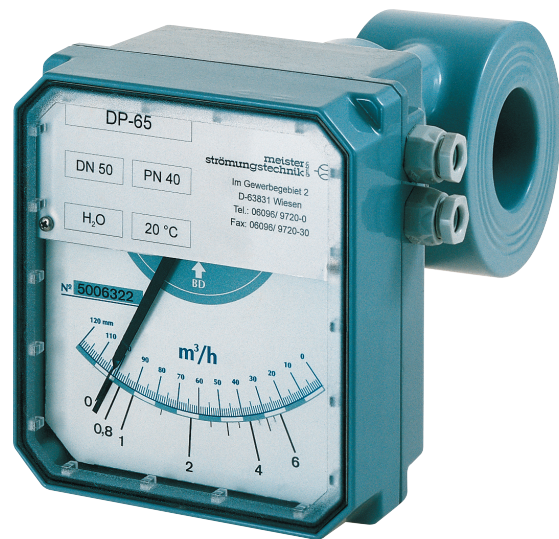

### Operation

The instruments, type DP-65, are target-disc flowmeters



### Application

The flowmeters, type DP-65, are employed to monitor the volume flow of liquids.

The instruments are used in many different applications:

- water treatment
- chemical industry
- heating circuits
- pharmaceutical industry
- fire protection installations

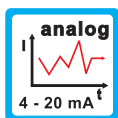
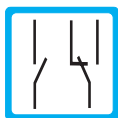
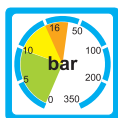
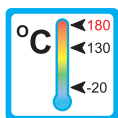

### Features

The DP-65 prove themselves through reliability and simple handling. Further properties of this sturdy series are:

- suitable for high temperature applications
- product designated scale at no charge
- sandwich mounting

### Installation hints

The flowmeter can be installed in any position in the system. The flow direction must be observed (refer to page 3).

The flowmeter must not be used as a supporting part in a pipe construction!

Keep adequate distance to magnetic fields (e.g. electric-motors)!

The operating instruction for DP-65 must be observed!



## Technical Data

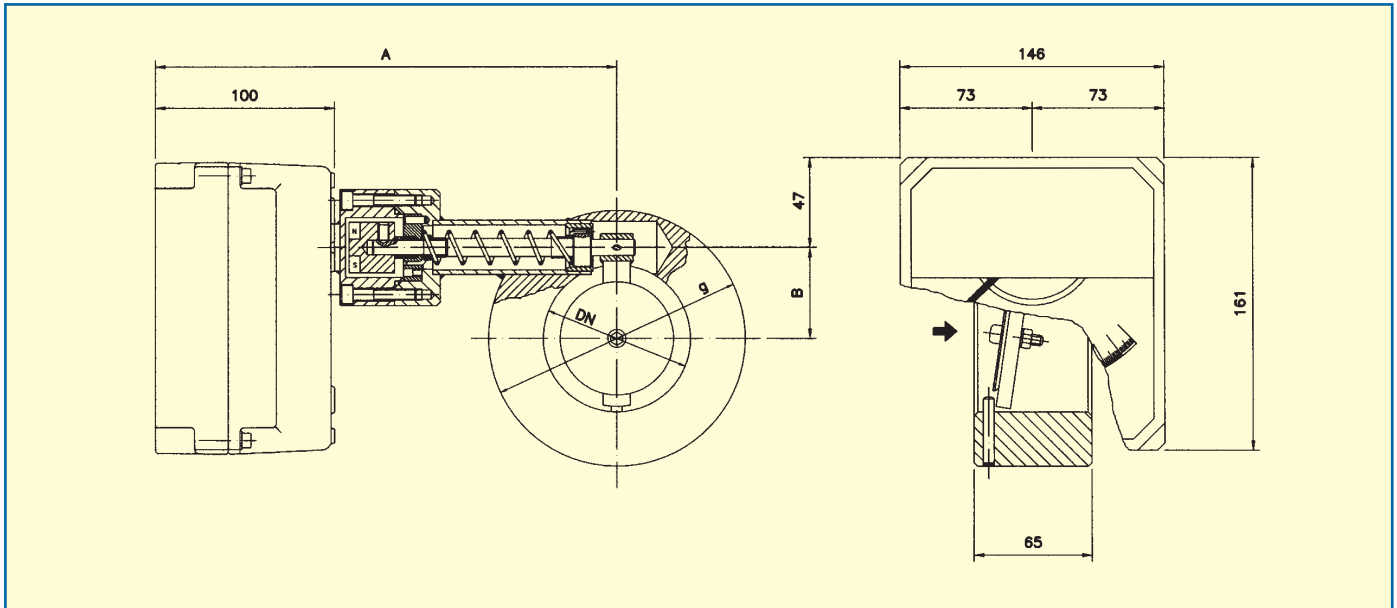

### Flow ranges, dimensions and weights

DN	Flow ranges (water at 20 °C)				g	Dimensions		Weight [kg]
	[m³/h]	[m³/h]	[m³/h]	[m³/h]		B	A	
40	0,8 - 4 / 6	1 - 8	2 - 10	3 - 16	88	28	250	5
50	0,8 - 6	2 - 10	3 - 16	3 - 25	102	33	250	6
65	2 - 10	3 - 16	3 - 25	4 - 30	122	40	250	7
80	2 - 16	3 - 25	5 - 40	10 - 60	138	50	250	8
100	5 - 40	8 - 60	10 - 80	12 - 90	158	60	250	10
125	8 - 60	15 - 100	15 - 120	20 - 135	188	70	280	12
150	15 - 100	20 - 160	25 - 200	40 - 220	212	78	280	14
200	20 - 160	30 - 250	40 - 350	—	268	90	320	20
250	25 - 200	50 - 400	60 - 500	80 - 600	320	102	350	29
300	30 - 250	50 - 400	80 - 600	100 - 800	370	115	370	35

### Technical data

<b>Measuring ranges:</b>		<b>Accuracy:</b>	
Water	refer to table above	standard	± 2,5 % of full scale
		optional	± 1,6 % of full scale
<b>Medium temperature:</b>		<b>Ambient temperature:</b>	
Steel coated (beschichtet)	-20 °C to +130 °C	Steel (coated)	-20 °C to +80 °C
Stainless Steel	-20 °C to +180 °C	Stainless Steel	-20 °C to +80 °C
<b>Pressure:</b>		<b>Viscosity max.:</b>	
DN-40 to DN-80	PN40	DN-100 to DN-200	PN16
DN-250 to DN-300	PN10		
<b>Pressure drop</b>	low pressure drop		
<b>Connection (standard):</b>	sandwich mounting		
<b>Scale:</b>	medium customised, 120 mm, various units e.g.: l/h, m³/h, kg/h		
<b>Special versions (on request):</b>			
High temperature version	-20 °C to +250 °C (in Stainless Steel only)		
<b>Ingress protection housing:</b>	IP 65	<b>Cable entry:</b>	PG9-cable gland

DP-65 2 0001 08-04 E M



# Materials, flow directions

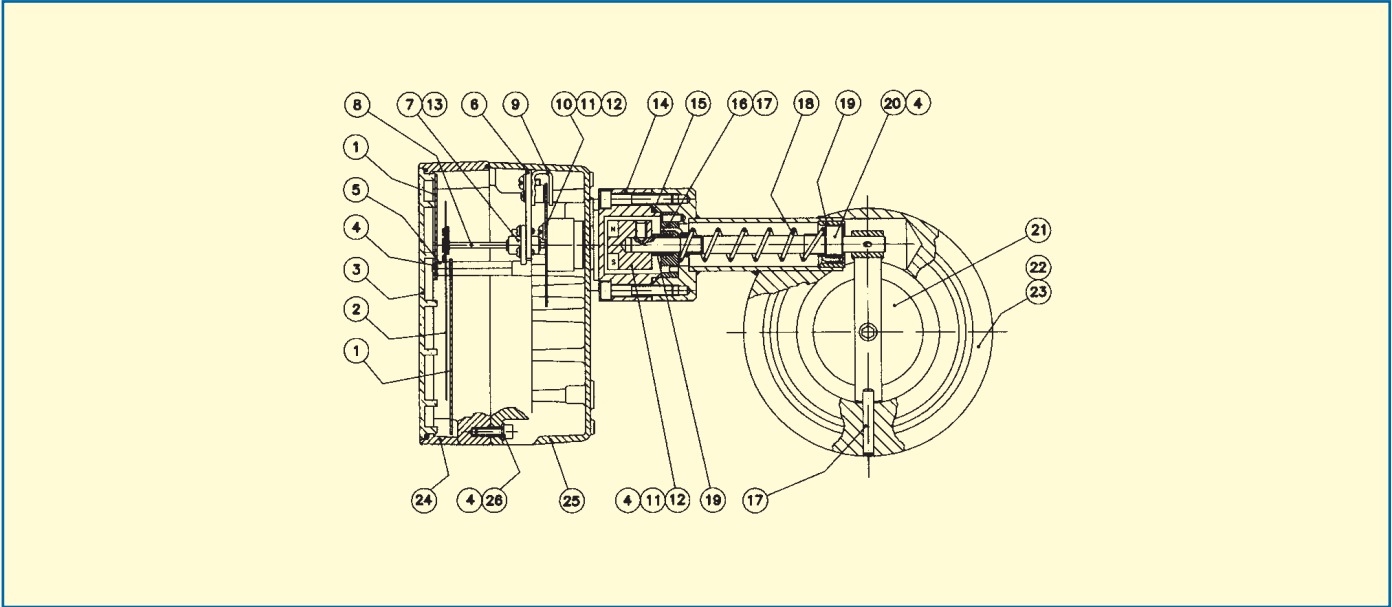

## Materials

No.	Description	Steel	Stainless Steel	No.	Description	Steel	Stainless Steel
1	Scale	Aluminum	Aluminum	14	Cocking bolt	1.4404	1.4404
2	Pointer	Aluminum	Aluminum	15	Gasket	NBR	NBR
3	Show glass	Polycarbonate	Polycarbonate	16	Spring pad	1.4404	1.4404
4	Screw	1.4401	1.4401	17	Pin	1.4404	1.4404
5	Scale carrier (2-parts)	Brass chrome plated	Brass chrome plated	18	Spring	1.4310 NS	1.4310 NS
6	Linkage	Aluminum	Aluminum	19	Bushing	PTFE	PTFE
7	Bearing	Brass chrome plated	Brass chrome plated	20	Axle	1.4404	1.4404
8	Axle	1.4404	1.4404	21	Target disc	1.4404	1.4404
9	Magnet	Alnico	Alnico	22	Armature	Steel	1.4401
10	Brake disc	Aluminum	Aluminum	23	Lining	Polyamid 11	—
11	Magnet seat	Aluminum	Aluminum	24	Cover	Aluminum	Aluminum
12	Magnet	Alnico	Alnico	25	Housing	Aluminum	Aluminum
13	Bearing	1.4037	1.4037	26	Washer	Akulon	Akulon

wetted parts

## Flow directions

from bottom to top	from top to bottom	from left to right	from right to left

Please advise flow direction when ordering !

DP-65 3 0001 08-04 E M



# Electronic measuring transducers and limitswitches

## Adjustable micro-limitswitch type DP-AMM

Bistable microswitch (change over) installed in the indicator housing of the flowmeter

- DP-AMM1: 1 adjustable limitswitch
- DP-AMM2: 2 adjustable limitswitches
- Switch values: 3 (1) A / 250 V (VDE/CEE)
- Hysteresis:  $\pm 10\%$  of endvalue
- Ambient temperature:  $-25\text{ }^{\circ}\text{C}$  to  $+80\text{ }^{\circ}\text{C}$
- Mechanical lifetime:  $10^7$  switch operations
- Supply: 220 V AC, load: 6 A      24 V DC, load: 0,5 A

(gold plated on request)

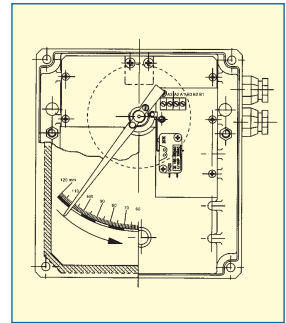

## Adjustable inductive limitswitch type DP-AMD

Inductive proximity switch, 3,5 mm, according to standard NAMUR DIN 19234, installed in the indicator housing of the flowmeter

- DP-AMD1...2: 1...2 adjustable limitswitches
- Power supply: 8 V DC (via amplifier)
- Temperature:  $-25\text{ }^{\circ}\text{C}$  to  $+70\text{ }^{\circ}\text{C}$

### Amplifier (on request)

Model NAMUR (DIN 19234) for 1 or 2 adjustable inductive contacts

- Power supply: 24...230 V AC, 50 - 60 Hz      24...250 V DC
- Input: intrinsic safe circuit EEx ia IIC
- Output: 1 or 2 relays
- Load: 2...5 A / 40 V DC
- Temperature:  $-25\text{ }^{\circ}\text{C}$  to  $+70\text{ }^{\circ}\text{C}$

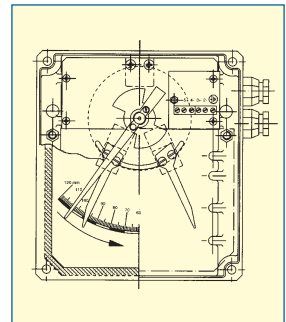

## Electronic measuring transducer HALLTEC III

The HALLTEC III is a transducer in 2 wire or 4 wire technique with a hall effect sensor. The hall sensor is based on the non contact sensing through the indicator mechanism.

### Model:

- |                              |                              |
|------------------------------|------------------------------|
| 2 wire:                      | 4 wire:                      |
| TH32 transducer              | TH34 transducer              |
| TH32T transducer + totalizer | TH34T transducer + totalizer |

- Power supply: 10...50 V DC (2 wire), 24...240 V AC (4 wire)
- max. current / load consumption: max. 20 mA (2 wire), < 2 VA (4 wire)
- Analog output: 4 - 20 mA
- Accuracy: 0,6 % referenced to the magnet position
- Load max.: 2 k $\Omega$
- Pulse output: MOSFET potentialfree N-channel
- I max.: 200 mA
- max. frequency: 2 Hz
- Pulse length: approx. 250 ms
- Totalizer: 9 digits, 4,5 mm peak with reset via potentialfree contact
- Ambient temperature:  $-25\text{ }^{\circ}\text{C}$  to  $+70\text{ }^{\circ}\text{C}$

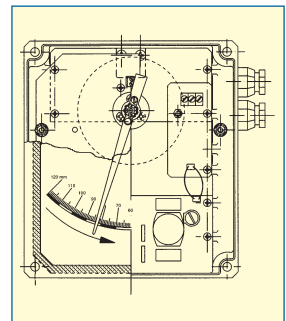

## Electronic measuring transducer HALLTEC III (EEx ia IIC T4 ATEX)

### Model:

- |                                |
|--------------------------------|
| 2 wire:                        |
| TH32Ex transducer              |
| TH32TEx transducer + totalizer |

- max. current: 20 mA
- Analog output: 4 - 20 mA
- Accuracy: 0,6 % referenced to the magnet position
- Load max.: 700  $\Omega$  at 24 V DC power supply
- Totalizer: 9 digits, 4,5 mm peak with reset via potentialfree contact
- Ambient temperature:  $-5\text{ }^{\circ}\text{C}$  to  $+40\text{ }^{\circ}\text{C}$

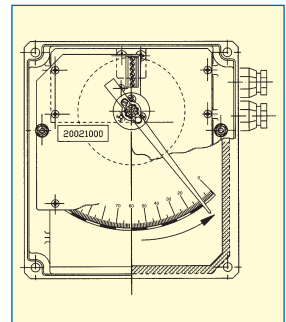

DP-65 4 0001 08-04 E M



Flow limiter

Type: **BA/BB/BC**

9

**BA / BB / BC**

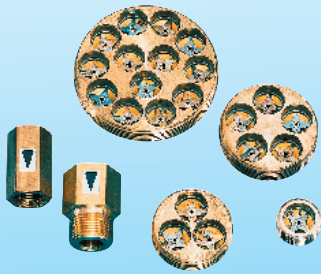

**Flow limiter for liquids**

- high reliability
- installation in any orientation
- suitable for hot water
- thread connection

## BA, BB, BC

### Operation:

The flow limiters work on a pure mechanical base and do not require any external power source.

The cross sectional area, available to the flowing medium, will change with pressure changes in that way, that an almost constant flow stream can be maintained.



### Application

The flow limiters model BA, BB and BC are used to maintain a constant or restrict a flow stream of liquids.

The flow limiters are employed, besides other applications, in the following areas:

- Water treatment
- Irrigation
- Sanitary installations

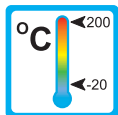

### Features

The flow limiters work in the control pressure range of 2 to 10 bar.

Further features of these sturdy units are:

- any mounting position
- high functional reliability
- suitable for hotwater
- Thread connections

### Installation hints

The installation of the limiters can be done in any way in the system. The flow direction must be observed.

The limiters must not be used as supporting part in a pipe structure.

The liquid must not contain any solid particles!

We recommend the installation of strainers, model SFD or SFM.



# Technical data

## BA

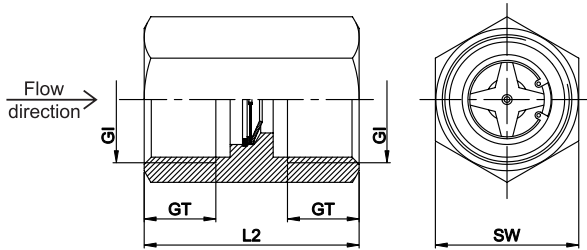

Type	GI1	GI2	GT [mm]	SW [mm]	L2 [mm]	Weight [g]
BA	G 1/2"	G 1/2"	14	24	43	72
BA	G 3/4"	G 3/4"	15	30	45	125

Ranges: 1 - 30 l/min in 1 l/min - steps

## BB

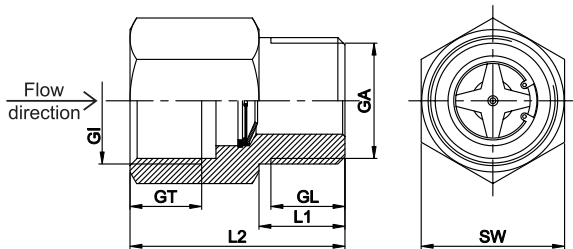

Type	GI/GA	GT [mm]	GL [mm]	SW [mm]	L1/L2 [mm]	Weight [g]
BB	G 1/2"	14	14	24	16/43	71
BB	G 3/4"	15	15,5	30	18/45	135

Range: 1 - 30 l/min in 1 l/min - steps

## BC

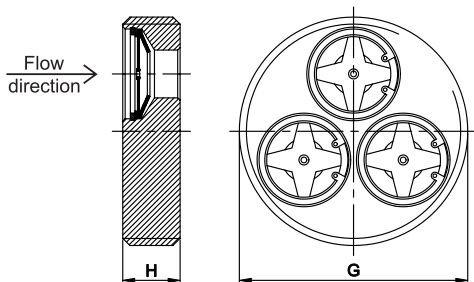

Type	G	H [mm]	Q <sub>min</sub> * [l/min]	Q <sub>max</sub> * [l/min]	Weight [g]
BC	G 3/4"	12	1	30	25
BC	G 1 1/2"	12	3	90	104
BC	G 2"	15	5	150	190
BC	G 2 1/2"	15	9	270	290
BC	G 3"	15	13	390	375

\* from Q<sub>min</sub> to Q<sub>max</sub> in 1l/min - steps

Operating data	BA	BB	BC
min. control pressure		2 bar	
max. control pressure		10 bar	
Accuracy:	up to 2 l/min: ± 15% of nominal value, from 3 l/min: ± 10% of nominal value		
Temperature max.:	200 °C		
<b>Material:</b>	brass		stainless steel
Body:	brass		1.4305
Star:		1.4310	
Cone:		1.4301	
Rivet:		1.4301	
Retainerring:		1.4121	

Begrenzer 2 0002 05-04 E M



## VSB



### Volume stream block

- Flow regulation of liquids
- through combination extensible to multi circuit systems
- monitoring of the branches in conjunction with flow monitors

## NV



### Needle valve

- Flow regulation for liquids and gases

## SF / SFD / SFM

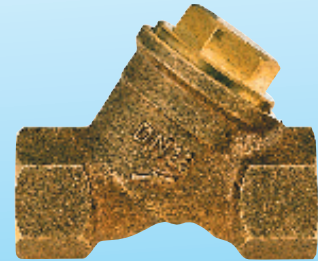

### Strainer for liquids and gases

- sturdy construction
- different materials
- different mesh sizes
- magnet separator (with SFM)

## ATD

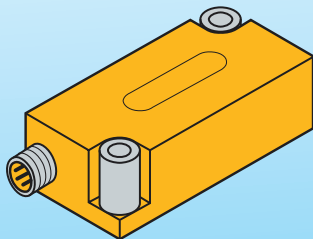

### Analog transmitter

- current and voltage output
- wide temperature range
- zero and span of the measuring range are separately adjustable

## KSR



### Contact protection relay

- Overload protection for reed switch

# Blockvalve VSB



## Operation

The blockvalve allows, through a built-in needle valve, to adjust the flow rate for each flow monitor and flow indicator. The VSB may be employed in single or multiple (up to 12 units) configuration (multiple configuration is factory assembled). The total max. flow rate in multiple configuration of 75 l/min and in single configuration of 25 l/min must not be exceeded.

## Areas of Application

Monitoring of central-lubrication or oil circulation-system lubrication.

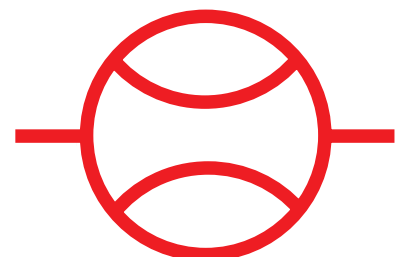

## Mounting hints

The feeding can be chosen from either left or right side.

5	Threaded-rod / Nut / Washer
4	Switch - housing / complete
3	Union
2	Body
1	Volumestream - block
Pos.	Description

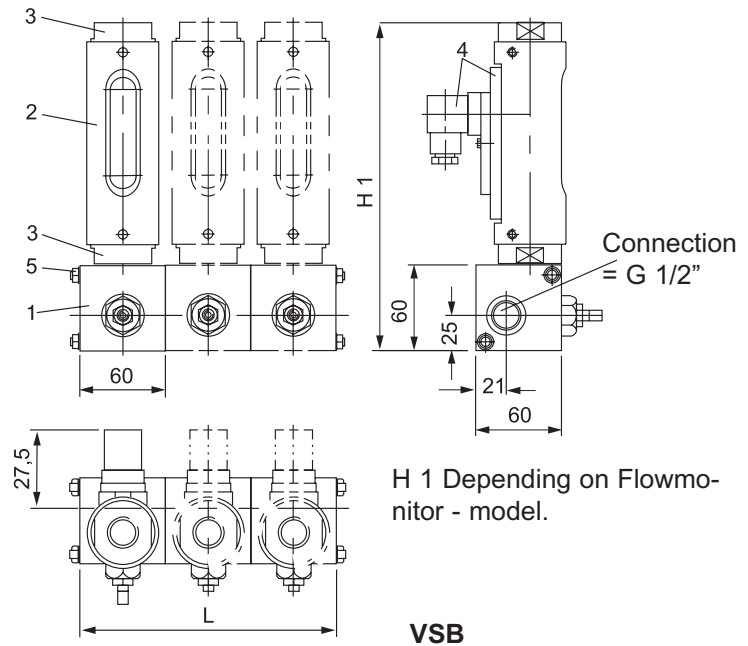

H 1 Depending on Flowmonitor - model.

**VSB**

<b>Operating Data:</b>	<b>VSB</b>	
Operating pressure max.	PN 16 bar	
Operating Temperature max.	100 °C	
<b>Material:</b>	<b>Aluminum</b>	<b>Stainless steel</b>
Body	Aluminum	1.4305(304)
Stem	Brass	1.4305(304)
Stemlocknut	Stainless steel 1.4305(304)	1.4305(304)
Gaskets	Viton	Viton
Other materials on request		

## Model overview VSB

Type	Dimensions mm					weight	
	G	H	D	Thread dep	L	Aluminum approx. g	Stainl. steel approx. g
VSB – 1	1/2"	60	60	14	60	560	1510
VSB – 2	1/2"	60	60	14	120	1180	3080
VSB – 3	1/2"	60	60	14	180	1770	4620
VSB – 4	1/2"	60	60	14	240	2360	6160
VSB – 5	1/2"	60	60	14	300	2950	7700
VSB – 6	1/2"	60	60	14	360	3540	9240
VSB – 7	1/2"	60	60	14	420	4130	10780
VSB – 8	1/2"	60	60	14	480	4720	12320
VSB – 9	1/2"	60	60	14	540	5310	13860
VSB – 10	1/2"	60	60	14	600	5900	1540
VSB – 11	1/2"	60	60	14	660	6490	16940
VSB – 12	1/2"	60	60	14	720	7080	18480

All rights reserved

**meister**  
**strömungstechnik**  
Im Gewerbegebiet 2 · D – 63831 Wiesen

Telefon : 0 60 96 / 97 20 - 0  
Telefax : 0 60 96 / 97 20 - 30  
E - Mail: Info@meister-flow.com  
Internet: http://www.meister-flow.com

# Needle Valve

## NV

### Operation

Seat and plug of the needle valve are conical shaped. By lifting or lowering the plug, the available cross-section can be increased or decreased, that way a fine adjustment of the actual flow is achieved.

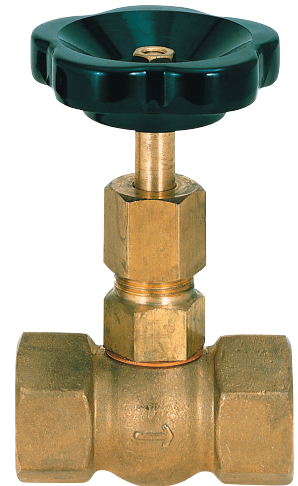
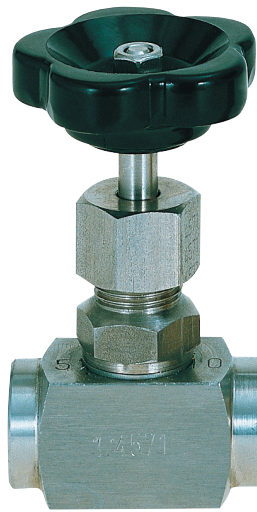

### Application

Flow-adjustment of liquids and gases.

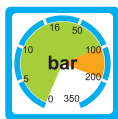
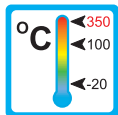

### Features

Characteristics of this sturdy type are:

- Suitability for high temperature
- high pressure resistance
- Threaded connections special threads on request

### Installation hints

The installation of the needle valve can be done in any way in the system. The flow direction must be observed.

The needle valve must not be used as a supporting part in a pipeconstruction!

The medium must not contain any solid particles!  
We recommend the installation of strainer type SFD or SFM.

NV 1 0001 07-04 E M



# Technical Data

## NV Stainless Steel

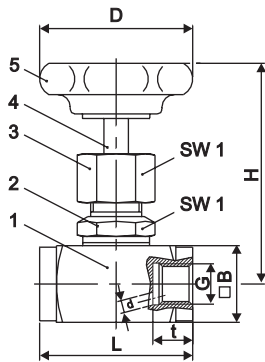

Pos.	Description	Material
1	Body	1.4571
2	Stemguide	1.4571
3	Stuffing-box nut	1.4571
4	Stem	1.4571
5	Handwheel	Plastic
not illustrated	Stem sealing	Teflon, optional Graphite

Thread	L	H	D	t	B	SW 1	d	kv-value*
G 1/8"	45	70	50	11	25	22	4	4
G 1/4"	50	72	50	13	25	22	5	8
G 3/8"	55	72	50	13	25	22	6	10
G 1/2"	60	72	63	16	30	22	7	12
G 3/4"	75	95	63	18	35	27	9	18
G 1"	100	110	90	22	45	32	12	32
G 1 1/4"	110	130	100	24	60	41	15	60
G 1 1/2"	130	140	100	28	70	41	22	115
G 2"	130	140	100	28	70	41	22	130

\*in l/min, at 1 bar differential pressure and max. opening

Technical Data				
Connection:	Withworth - pipe thread according to DIN 259, female both sides (other on request)			
Temperature max.:	250 °C (350 °C with graphite stem sealing)			
Nominal Pressure (PN):	200 bar, from 50 °C watch pressure derate			
Pressure derate:	at 50 °C: 6%	at 100 °C: 15 %	at 200 °C: 37%	at 300 °C: 60 %    at 400 °C: 84 %

## NV Brass

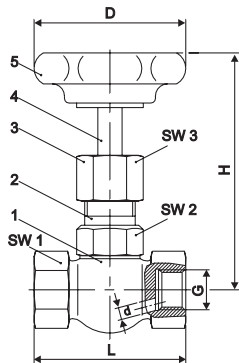

Pos.	Description	Material
1	Body	Cu Zn 39 Pb 3 F 37
2	Stemguide	Ms 58
3	Stuffing-box nut	Ms 58
4	Stem	Ms 58
5	Handwheel	Plastic
not illustrated	Stem sealing	G 1/8" to G 1/2" Perbunan G 3/4" to G 2" Teflon

Thread	L	H	D	SW 1	SW 2	SW 3	d	kv-value*
G 1/8"	50	70	50	22	19	19	4	4
G 1/4"	50	78	50	22	19	19	5	8
G 3/8"	50	78	50	22	19	19	6	10
G 1/2"	55	78	63	25	19	19	6,5	11
G 3/4"	67	90	63	32	22	22	9	18
G 1"	75	95	63	40	22	22	11	—
G 1 1/4"	110	105	90	54	24	27	13	—
G 1 1/2"	110	110	90	58	24	27	15	—
G 2"	110	110	90	70	27	27	15	—

\*in l/min, at 1 bar differential pressure and max. opening

Technical Data				
Connection:	Withworth - pipe thread DIN 259, female both sides (other on request)			
Temperature max.:	100 °C			
Nominal pressure (PN):	100 bar, from 50 °C watch pressure derate			
Pressure derate:	at 50 °C: 6 %	at 100 °C: 15%		



## SF, SFD, SFM

### Operation

Inside the strainer a screen basket is fitted to retain solids. Additionally the type SFM is equipped with magnets to withhold ferromagnetic particles.

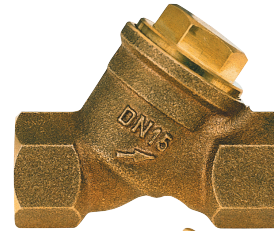
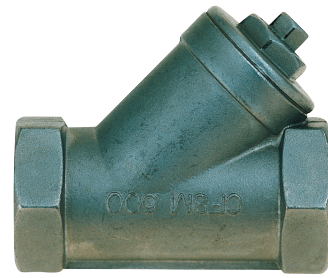

### Application

Retaining of particles contained in liquids or gases.

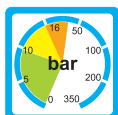
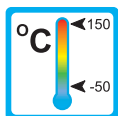

### Features

Characteristics of this sturdy type are:

- high temperature resistance
- high pressure resistance
- Magnet separator (SFM only)
- Easy maintenance
- Threaded connection  
Special threads on request

### Installation hints

The installation of the strainer can be done in any way in the system. The flow direction must be observed.

The strainer must not be used as a supporting part in a pipe-construction.



# Technical Data

## SF, SFD, SFM

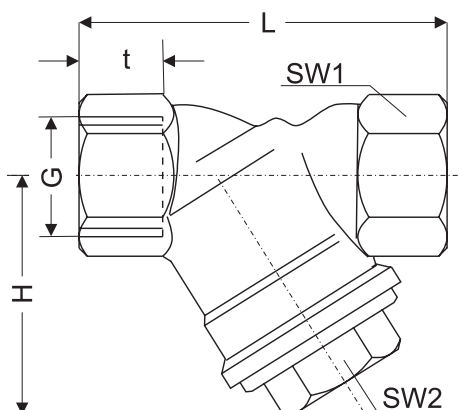

G	Type	Material			Type	Material			Type	Material		
		RG	MS	VA		RG	MS	VA		RG	MS	VA
1/4"	SF-8	x			SFD-8	x						
3/8"	SF-10	x			SFD-10	x						
1/2"	SF-15	x		x	SFD-15	x		x	SFM-15	x		x
3/4"	SF-20	x		x	SFD-20	x		x	SFM-20	x		x
1"	SF-25	x		x	SFD-25	x		x	SFM-25	x		x
1 1/4"	SF-32	x		x	SFD-32	x		x	SFM-32	x		
1 1/2"	SF-40	x		x	SFD-40	x		x	SFM-40	x		
2"	SF-50	x		x	SFD-50	x		x	SFM-50	x		
2 1/2"	SF-65		x		SFD-65		x					
3"	SF-80		x		SFD-80		x					
				Strainerbasket: 0,6 mm mash size stainless steel		Strainerbasket: 0,25 mm mash size stainless steel				Strainerbasket: 0,6 mm mash size stainless steel Magnets: hardferrite		
				RG: red brass		MS: brass				VA: stainless steel		

Type	Overall dimensions [mm]						PN		
	G	L	t	H	SW1	SW2	RG	MS	VA
SF-8	1/4"	56	11	35	21	17	16	-	-
SF-10	3/8"	56	11	35	21	17	16	-	-
SF-15	1/2"	66	13	42	27	22	16	-	40
SF-20	3/4"	77	14	50	31	27	16	-	40
SF-25	1"	90	15	62	38	32	16	-	40
SF-32	1 1/4"	112	18	78	47	41	16	-	40
SF-40	1 1/2"	120	18	82	54	46	16	-	40
SF-50	2"	150	22	95	66	56	16	-	40
SF-65	2 1/2"	220	23	125	85	70	-	-	-
SF-80	3	243	26	140	100	75	-	-	-

Type	Overall dimensions [mm]						PN		
	G	L	t	H	SW1	SW2	RG	MS	VA
SFD-8	1/4"	56	11	35	21	17	16	-	-
SFD-10	3/8"	56	11	35	21	17	16	-	-
SFD-15	1/2"	59	12	40	29	19	16	-	40
SFD-20	3/4"	77	14	50	31	27	16	-	40
SFD-25	1"	90	15	62	38	32	16	-	40
SFD-32	1 1/4"	112	18	78	47	41	16	-	40
SFD-40	1 1/2"	120	18	82	54	46	16	-	40
SFD-50	2"	150	22	95	66	56	16	-	40
SFD-65	2 1/2"	220	23	125	85	70	-	16	-
SFD-80	3	243	26	140	100	75	-	16	-

Type	Overall dimensions [mm]						PN		
	G	L	t	H	SW1	SW2	RG	MS	VA
SFM-15	1/2"	66	13	42	27	22	16	-	16
SFM-20	3/4"	77	14	50	31	27	16	-	16
SFM-25	1"	90	15	62	38	32	16	-	16
SFM-32	1 1/4"	112	18	78	47	41	16	-	-
SFM-40	1 1/2"	120	18	82	54	46	16	-	-
SFM-50	2"	150	22	95	66	56	16	-	-





# Analog transmitter

## ATD

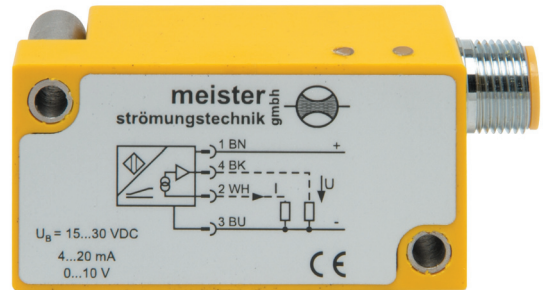

### Operation

Magnet-inductive linearway sensors detect the position of the magnet float and provide an analog signal.

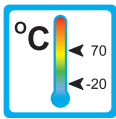

### Application

The analog transmitter type ATD can be used in combination with various flowmeters (see table page 2).

Then they produce an appropriate signal for the respective flow.

The signal can be employed by the user for most different measuring applications and tasks of regulation.

Areas of application:

- Coolingsystems and cooling circuits
- Medicine technology
- Pharmaceutical industry
- Chemical industry
- Research and development



### Features

The ATD series proves itself through reliable function and high repeatability. Further characteristics of this series are:

- analog output (4 - 20 mA / 0 - 10 V)
- high temperature range
- high electromagnetic compatibility
- Zero and span of the measuring range separately adjustable (2 potentiometer)

### Installation hints

The analog transmitter type ATD must be used only in combination with the flowmeters indicated on page 2 (table).

The operating instruction for ATD must be observed under any circumstances!



# Technical Data

## Dimensions

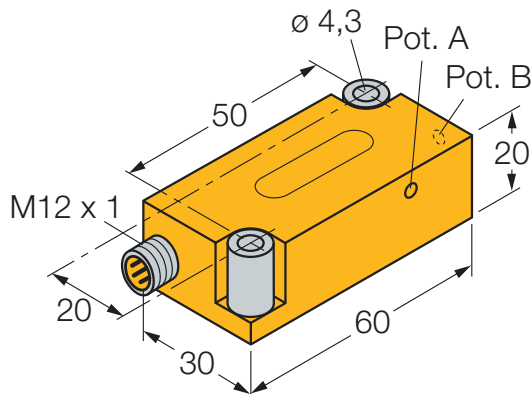

## Application- / combination options

Type		Type		Type	
DKG-1	+	DWG-1,5 to DWG-18	+	RVO/U-1	+
DKG-2	-	DWG-35 to DWG-150	-	RVO/U-2	-
DKM-1	+	DWG-L1,5 to DWG-L18	+	RVO/U-L1	+
DKM-2	-	DWG-L35 to DWG-L150	-	RVO/U-L2	-
DKM/A	+	DWM-1,5 to DWM-18	+		
DKME	+	DWM-35 to DWM-150	-		
DKME/A	+	DWM-L1,5 to DWM-L18	+	RVM/U-1	+
		DWM-L35 to DWM-L150	-	RVM/U-2	-
		DWM/A-1,5 to DWM/A-18	+	RVM/U-L1	+
DUG-4 to DUG-45	+	DWM/A-35 to DWM/A-150	-	RVM/U-L2	-
DUG-70 to DUG-250	-	DWM/A-L1,5 to DWM/A-L18	+		
DUM-4 to DUM-55	+	DWM/A-L35 to DWM/A-L150	-		
DUM-70 to DUM-250	+				
DUM/A-4 to DUM/A-55	+				
DUM/A-70 to DUM/A-250	-				

+ Combination possible    - Combination not possible

## Technical Data

Measuring range [A...B]:	10...50 mm (adjustable 2 Potentiometer)
Repeatability:	≤ 0,5 % of range [A...B] (≤ depending on positioner)
Linearity error:	≤ 10% of full scale of the flowmeter
Temperature drift:	≤ ± 0,09 % / K
Operating temperature:	-20 °C...+70 °C
Operating voltage $U_B$ :	15...30 VDC
Residual ripple:	≤ 10 % $U_{SS}$
No-load current $I_0$ :	≤ 23 mA
Design breakdown voltage:	≤ 0,5 kV
Output function:	4 wire, analog output
Short-circuit protection:	yes
Wire rupture safety / polarity reversal protection:	yes / complete
Analog output (voltage):	0...10 V
Analog output (current):	4...20 mA
Load resistance voltage output:	≥ 4,7 kΩ
Load resistance current output:	≤ 0,4 kΩ
Measuring frequency:	800 Hz
Recovery time at output:	≤ 12 ms
Housing material:	Plastic, PBT-GF20-V0
Connection:	Plug, M12 x 1
Vibration stability:	55 Hz (1 mm)
Shock resistance:	30 x g (11 ms)
Ingress protection:	IP 67

## Measuring range

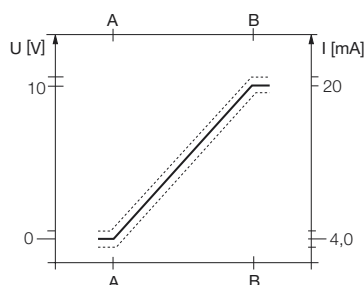

## Connection diagram

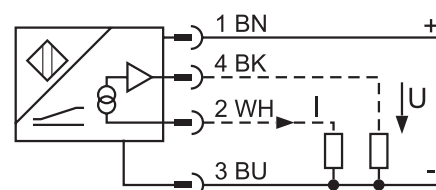

ATD 2 0001 06-04 E M

# Kontaktschutzrelais KSR



Kontaktsschutzrelais sind Schaltgeräte, mit denen eine höhere Schaltleistung erzielt werden kann. Sie dienen als Überlastungsschutz für die in unseren Strömungswächtern verwendeten Reedkontakte und wurden speziell auf diesen Anwendungsfall abgestimmt; zur Vermeidung von Schwingungen ist das Gerät mit einer fest eingestellten Ein- und Ausschaltverzögerung von 2 sec. ausgestattet.

Das Kontaktsschutzrelais **KSR** stellt einen potentialfreien Wechselkontakt zur Verfügung, der zur Ansteuerung von größeren Lasten, wie z.B. Pumpen, Magnetventilen o.ä. verwendet werden kann.

Reedkontakte haben im allgemeinen eine sehr lange Lebensdauer, sofern sie innerhalb der zulässigen elektrischen Werte betrieben werden. Auf Überlastungen reagieren sie allerdings äußerst empfindlich, d.h. die angegebenen Maximalwerte dürfen unter keinen Umständen auch nicht kurzzeitig (z.B. durch Ein- oder Ausschaltspitzen) überschritten werden.

Eine solche kurzzeitige Überlastung hat fast immer eine dauerhafte Beschädigung des Reedkontaktes zur Folge.

Gefahr der Überlastung von Reedkontakten besteht bei:

- Induktiven Lasten (Spannungsspitzen beim Ein- oder Ausschalten).
- Kapazitäten (Stromspitzen beim Einschalten)
- Ohmschen Lasten, speziell Lampen (Stromspitze beim Einschalten durch kalte Glühwendeln).

Bei den obigen Beispielen können die auftretenden Strom- bzw. Spannungsspitzen durchaus ein vielfaches des Nennwertes betragen. Deshalb sollte im Zweifelsfall das Kontaktsschutzrelais zum Einsatz kommen, um Störquellen durch beschädigte Reedkontakte zu vermeiden.

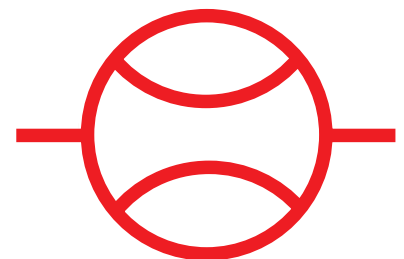

## Einbaumaße

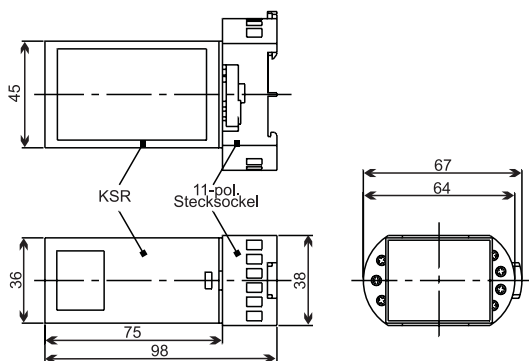

## Schaltbild

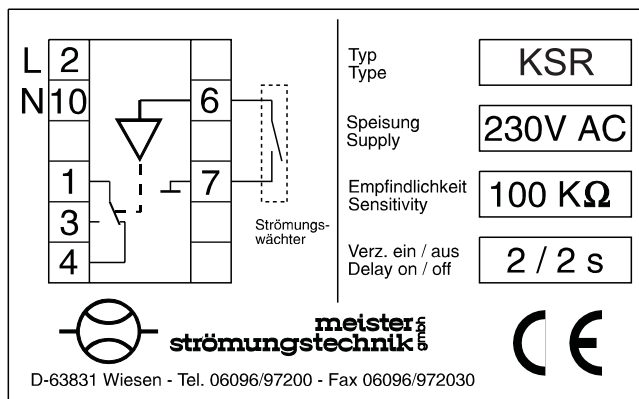

Technische Daten	KSR
Abmessungen (H x B x T)	45 x 36 x 75 mm
(T) mit 11-pol. Stecksocket für DIN - Schiene 4677 (EN 50022)	98 mm
Betriebstemperatur	-10 °C bis +70 °C
Speisung	230 V AC 50 – 60 Hz (24 V + 115 V auf Anfrage)
Relais - Ausgang	aktiv bei geöffnetem Reed-Kontakt, Kontaktmaterial: Ag
Schaltleistung	230 V AC / 5 A
max. Kabellänge Strömungswächter - KSR	40 m
Schutzisolierung	4,0 kV

Es gelten die allgemeinen Geschäftsbedingungen der Meister Strömungstechnik GmbH • Irrtum und technische Änderung vorbehalten



**CATEGORY UNDER CONSTRUCTION**